

# Application Note



## Installation and Maintenance of Cellular Base Stations with the 2397 and 2399A Spectrum Analyzer

by Jean Jaques Perret



### Measurements on Antennas and Transmitters with the 2397 and 2399A Spectrum Analyzer

#### Introduction

The use of digital cellular telephone systems continues to expand worldwide. Now customers are using GSM, PCS, DCS and DAMPS and they are going to use 2.5 G and 3 G in the near future. These systems work within a frequency range of between 800 MHz and 2.5 GHz. In addition,

the traditional Private Networks are being converted into digital with systems like TETRA.

The quality of service a network operator can provide is heavily dependant on the performance of the base station which depends on the performance of the antenna and coaxial feeder connected to the base station. A

degraded antenna installation can result in dropped calls and poor coverage. This leads to irate customers and lost revenue.

Network operators need to verify the base station, its feeder and antenna performance when installing and commissioning a system. To ensure continued quality performance a regular maintenance policy should be implemented. Factors such as corroded connectors, bends, joints, water ingress into the coaxial feeder and de-tuned antennas can all cause the system performance to degrade rapidly.

When installing and maintaining an RF feeder, the key measurement to test the quality of the system is the feeder and antenna return loss (or VSWR).

If the return loss measurement fails to meet specification, a fault location measurement can be used to provide a precise identification of the faulty component.

The 2397/99A Distance to Fault (DTF) option provides a quick and convenient method of measuring return loss (VSWR) and fault location on coaxial transmission lines. They produce the real time measurement of return loss or fault location. The high selectivity of the spectrum analyzer is a big advantage as this measurement is performed in a highly polluted RF environment.

Combined with the versatility of the 2397/99A Spectrum Analyzer, the DTF option allows for full characterization of transmission line systems in terms of their frequency and distance response. When commissioned the system performance can be verified and stored. The data can then be used for comparison purposes during future routine maintenance testing. Hence, any degradation can be detected and cured at an early stage, before the system fails.

This article describes the different measurements including return loss (VSWR) and fault location using the 2397/99A Spectrum Analyzer.

## Reflection Measurements

The measurement of return loss (or VSWR) is a basic measurement used for the characterization of a system in the frequency domain. The measurement involves applying a RF signal over the operating bandwidth of the system and measuring the amount of power reflected by impedance discontinuities within the system. The source of the RF signal is the tracking generator while the spectrum analyzer is the measuring system.

The return loss is simply the ratio of reflected signal to input signal, expressed in dB.

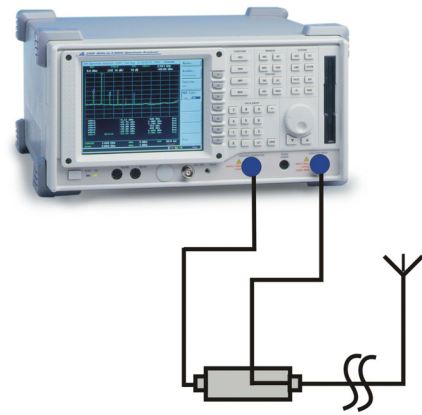

*Fig 1 shows the measurement setup.*

A directional device is required to separate the input and reflected signals. Calibration is performed by connecting an open or short circuit to the test port. These fully reflected devices allow correction for losses within the directional device and set the 0dB reference on the spectrum analyzer display.

For coaxial systems the directional device generally takes the form of a bridge network which offers high directivity, good test port match and operates over extremely wide bandwidths.

The two main figures of merit for the return loss bridge are directivity and test port match. The effect of these will produce errors in the measurement.

Directivity quantifies the imperfections within the bridge which cause a small amount of the input signal to be reflected before it reaches the test port. Hence, even with a "perfect" matched load connected to the test port a finite signal will be detected.

The test port match is also a product of imperfections in the bridge network but it depends on the match of the source connected to the RF input port. It is desirable to have as good a test port match as possible to reduce the mismatch error signals between the Device Under Test (DUT) and the test port.

Fault location measurements also involve applying a RF signal to the transmission line over the operating bandwidth (as in the return loss measurement). The reflected signals are re-combined with the input signal to produce a ripple pattern. This ripple pattern has, encoded within it, amplitude and distance information for all the reflections occurring within the line. A Fourier transform is required to decode this complex waveform. Calibration is performed by connecting a matched load to the test port and normalizing the response to the input signal level.

Fault location theory is discussed in Appendix A.

## Spectrum Analyzer setup

The test setup for making return loss measurement using a 2397/99A Spectrum Analyzer and a Return Loss Bridge is shown in Figure 2.

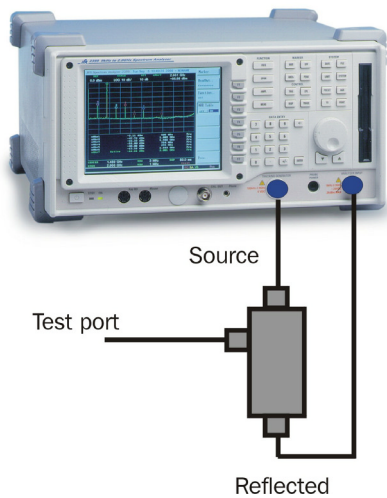

Figure 2

The RF cables connect the Source input of the bridge to the tracking generator output and the reflected output to the spectrum analyzer input. Calibration is performed using an open or short circuit (or keeping the test port open).

The following section uses as an example, the measurement of a 900/1000 MHz antenna system. The system consists of a 1.5 meter coaxial jumper cable, a 25 meter coaxial feed and antenna.

### Conventions

These conventions are used within this application note to indicate a 2397/99A key press:

[BOLD] - Hardkey press, i.e. a dedicated front panel function key.

[italic] - Softkey press, i.e. software menu key.

Numeric entries are made using either keypad or rotary control. Keypad entries must be followed by a terminator key.

### Return loss

From the "Preset" condition, all instrument settings will be set to the default values.

[PRESET]

[SYSTEM]

[DTF Model]

[Meas.Type/ REFLT]

[Config]

The REFLECT CONFIGURATION screen appears

Use the rotary control to select Frequency/ Span

[Edit]

[1][0][0] [ENTER]

Use the rotary control to select Frequency/ Center

[Edit]

[9][5][0] [ENTER]

Then go to the calibration menu using:

[Enter]

To calibrate, leave the test port open.

Do Flatness?

[Yes]

The 2397/99A Spectrum Analyzer performs the calibration and displays a normalized response at 0 dB. The transmission line can now be connected.

The measurement can be alternatively displayed in return loss or VSWR format. To select it, type: [View Type/RETL/VSWR]

If required, markers can be selected using the [MKR] menu. Up to nine markers can be activated.

Limit checking can be performed automatically by applying a limit specification table. A table is produced by entering the table editor. As an example, to set a typical flat limit specification at -22 dB. See fig 3.



Figure 3

[LIMIT]

[Make Limit]

[Select/Up]

Use the rotary control and toggle the [Axis/X/Y] softkey to set the first limit point. The X and Y position of the point are displayed at the bottom line of the screen. When adjusted, press [Mark Dot]. This point will be recorded and you can move the limit point to the next X/Y position. Repeat the operation up to the limit line is complete.

If a low limit is required, then repeat the operation with the [Select/Low] softkey.

When finished, you can save the limit table pressing the [SAVE] key. Then press [End] to return to the main limit menu and press [UpPassChk/On] to activate the limit test. An audible alarm will be provided when out of limit if [Alarm/On] has been chosen.

A message "Upper Pass/Fail" will be displayed accordingly.

## Other return loss measurements

Most operators want to have comprehensive information on their system and they require the installation and commissioning company to provide test results on specific parts of the antenna. Therefore several different measurements using the return loss bridge can be performed.

Operators want to know the return loss of the feeder alone. For this measurement, the antenna is replaced by a 50 Ohm u/c reference load. The screen will display the response of the feeder itself.

They need to also know the total attenuation of the feeder. This will be done with the feeder open at its end. In this case the full generator power will be reflected excluding the loss occurring within the feeder. Note! The screen will display a curve result representing twice the feeder loss, as it displays the total of forward and return attenuation loss.

## Fault location

If the return loss or VSWR measurement of an antenna and feeder meets the specification, typically 20 or 25 dB, it is usual to archive the measurement trace for future reference. Please notice that the 2397/99A Spectrum Analyzer allows for storing traces in both data (Trace) or bitmap (BMP) format.

When the return loss fails to meet specification, it is necessary to identify the cause of the poor performance. This could simply be a loose connector or a more subtle fault, such as water ingress or kinked cable. In some cases, a poor return loss can be the result of a combination of smaller discontinuities.

A typical antenna feed can be over 80 meters long. Clearly a method of quickly identifying the position of the fault along the cable is required.

The fault location measurement of the 2397/99A is specifically designed to provide, with pin-point accuracy, the position of cable faults.

The computing power of the DTF option is high enough to provide real time observation of faults in the distance domain. This is particularly useful for determining the position of intermittent faults.

The DTF option requires a simple power divider as an external component. The input of the power divider is connected to the output of the tracking generator, while one output is connected to the spectrum analyzer input and the other to the calibration load or the DUT. See fig 4.

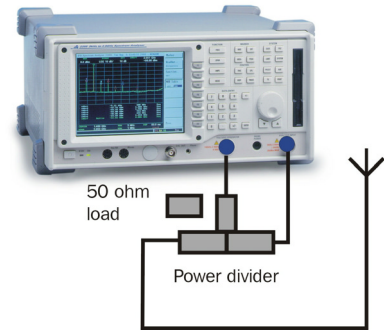

Figure 4

To perform the measurement, in the "DTF Meas" menu, select [Meas. Type/DTF] then [Config]. See fig 5.

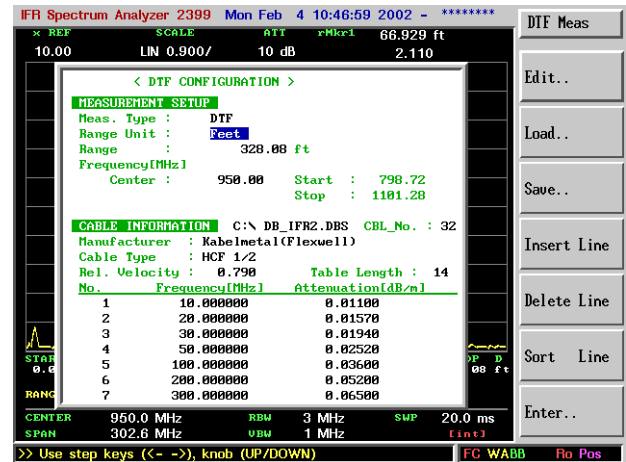

Figure 5

Use the rotary control to select "Range Unit" then press [Edit] and toggle between [Meter] and [Feet].

Then press [Enter & Next] and enter the distance range required. Example for a cable 80 meters long, we will type a higher value: [110] [ENTER].

Note: choosing a distance range can modify the frequency range where you expect to make the test. Sometimes it will be necessary to make a compromise between frequency range and distance range.

If you want to change the center frequency, select the parameter using the rotary control and type the new value, then press [ENTER].

To perform accurate measurements, it is necessary to feed the analyzer with accurate cable specifications of attenuation versus frequency and relative velocity. The 2397/99A DTF option is delivered with a cable database filled with data of the most used coaxial cables in the market. This database has been loaded into the 2397/99A memory. To select a particular cable, go to "Cable Type" using the rotary control, then press:

[Load]

[Load Cable Info.]

Using the rotary control, select the appropriate database (.DBS) file and press [Select].

Using the rotary control, select the appropriate cable reference and press [Select].

Pressing [Enter] will open the "DO FLATNESS?" menu.

Connect the 50 Ohm calibration termination to the test port of the power divider.

When done, press [Yes]: the analyzer displays the DTF measurement screen.

Disconnect the 50 ohm calibration terminator and connect the line under test to the test port.

Use [Display Zoom] to center the useful part of the result on the screen.

The result can be displayed either in return loss mode [View Type/RETL] or VSWR mode [View Type/VSWR]. See fig 6 and fig 7.



Figure 6

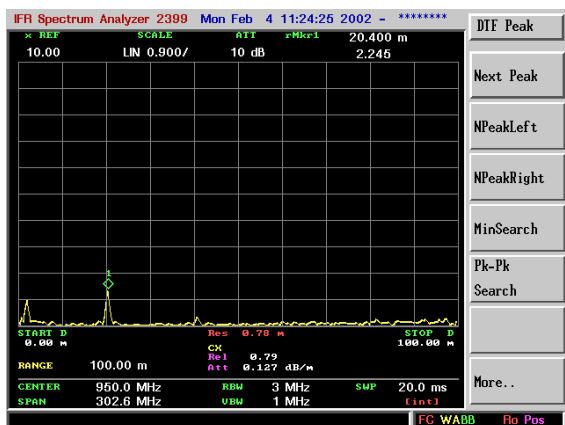

Figure 7

Marker functions can be used to accurately analyze the fault locations. Nine markers are available with different colors. Please notice that pressing the [MEAS] key will return to the DTF measurement screen. Also all measurement configurations and calibration data can be saved within internal memories and recalled later for new analysis or comparison.

The Distance to Fault measurement can be requested by an oper-

ator in order to check the exact length of cable supplied.

### Other measurements on Antennas

In many sites, the engineering company has required space diversity, which means that the transmitter antenna is separate from the receiver antennas. Therefore, it is required to test each antenna and cable separately and to measure the coupling factor between these antennas. Using the spectrum analyzer and its tracking generator solves the problem: the tracking generator output is connected to the spectrum analyzer input and a normalization calibration is performed. Then the tracking generator is connected to the transmitter antenna and the spectrum analyzer input to the receiver antenna. The screen displays the coupling factor in db between antennas.

Most of the time, the antenna system has been equipped on the receiver side with a low noise amplifier (LNA) aimed to increase the receiver sensitivity and improve the base station coverage. Again, operators require this amplifier to be tested. The same functions of the spectrum analyzer are used: the first solution is to use the coupling factor between antennas to transmit the signal to the receiver antenna. The normalization calibration is made with the LNA power off. Then the LNA is powered on and the spectrum analyzer will display the frequency response and gain of the LNA.

An alternative method is to disconnect the antennas at the top of the platform and to directly connect the cables. Then the same calibration and measurement process is applied.

Where LNAs exist, this measurement is mandatory.

### Other Base Station measurements

The versatile 2397/99A Spectrum Analyzer offers other measurement facilities very useful for base station commissioning and maintenance. Its basic functionality is to determine whether interfering signals are present at the base station location. In this case, the wide frequency coverage, high sensitivity and the ability to record and compare spectrums on the 2397/99A, are appreciated by users.

When the base station is powered on, the spectrum analyzer can be used to check the transmitter frequency and the transmitter power. This particular parameter is difficult to measure when using digital modulation. The 2397/99A Spectrum Analyzer function displays the power spectrum together with the integration bandwidth lines. Measurement is easy to analyze. See fig 8.

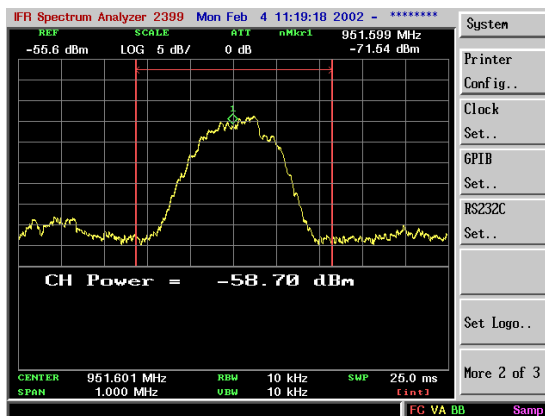

Figure 8

Channel frequency can also be measured accurately using the frequency meter function. For people requiring higher accuracy, a high stability time base option is available.

At the end, the tracking generator can be used to check whether the duplex filters are correctly tuned and to measure the loss occurring within the different interconnecting devices of the base station.

### Floppy disk storage

Measurements made when the base station is first installed should be archived for reference and comparison at a later date. There may be as many as 12 feeds at a single base station site and a convenient way of archiving results is to store them as trace memories on a 3.5 inch disk. The disk drive is a standard fitting built into the 2397/99A Spectrum Analyzer together with the C hard disk. Storing trace data is performed by inserting a formatted disk into the drive and pressing:

[FILE] then the destination disk [Disk/A:] or [Disk/C:]

Select the type of file:

[File Type/ State] to save a configuration

[File Type/Trace] to save a trace for further recall and comparison.

Also bitmap files can be saved for later use within reports.

To save bitmap files, press:

[SYSTEM]

[More 1 of 3]

[Printer Config.]

[Print Out to C] or

[Print Out to A] accordingly.

When the screen displays the information to save, press [PRINT]. The screen will be copied as a bitmap file into A or C.

### Summary

For network operators and commissioning companies who need to provide and maintain the highest level of performance from their base station, the 2397/99A Spectrum Analyzer provides a compact, portable instrument that can accurately characterize the base station antenna and feeder and check a big part of the transmitter. It is an ideal measurement system for both installation engineers and those responsible for implementing a structured routine maintenance policy.

### Appendix A: Fault Location Theory and Measurement Error

### Appendix A: Fault Location Theory and Measurement Errors

At the heart of time domain measurements using scalar data is the encoding of phase information in an amplitude response. This amplitude response is inverse Fourier transformed to give the required time/distance information. The phase encoding is performed by a symmetrical power divider as shown in Figure B1.

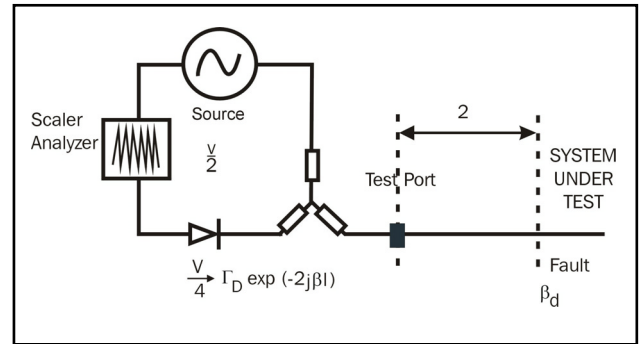

Figure B1 - Phase Encoding Symmetrical power divider

The source power sweeps over the required frequency range and the divider directs the power to both the scalar detector and system under test. An impedance discontinuity within the system will produce a reflected signal which has incurred a phase delay proportional to the distance from the center of the divider to the discontinuity. The reflected signal recombines with the reference signal at the divider center and the detector measures the magnitude of the vector sum of the two. As the frequency is swept, the phase between the reference and reflected signals varies and the amplitude response produced is a ripple pattern. The ripple amplitude is proportional to the reflection magnitude and has a period which is inversely proportional to the distance.

Assuming square law operation and a single fault, the output voltage  $V_d$  from the diode detector is given by:

where;-

$k$  is the detector sensitivity,

$V_0$  describes the wave magnitude incident on the divider input,

$G_d$  is the fault reflection coefficient and

$l$  is the distance from divider center to the fault.

Calibration is performed using a matched load ( $G_d = 0$ ), and results in a detector response  $V_{d1}$  where:

$$V_{d1} = k |V_0 s_{21}|^2$$

Normalizing all subsequent measurements by  $V_{d1}$  and subtracting 1 gives:

$$\frac{V_d}{V_{d1}} - 1 = \left| \frac{s_{31} s_{23} \Gamma_d}{s_{21}} \right|^2 + 2 \left| \frac{s_{31} s_{23} \Gamma_d}{s_{21}} \right| \cos 2\beta l$$

The Fourier transform of the above result yields:-

An impulse at zero distance, magnitude

$$\left| \frac{s_{31}s_{23}\Gamma_d}{s_{21}} \right|^2$$

An impulse at distance  $2l$ , magnitude

$$\left| \frac{s_{31}s_{23}\Gamma_d}{s_{21}} \right|$$

The fault location and its associated reflection coefficient have been found to be within a scaling factor defined by the scattering parameters of the divider. In practice the divider scattering parameters are characterized, and are accounted for in the MTS firmware.

**CHINA**

Tel: [+86] (21) 6282 8001  
Fax: [+86] (21) 6282 8002

**EUROPE**

Tel: [+44] (0) 1438 742200  
Fax: [+44] (0) 1438 727601

**FRANCE**

Tel: [+33] 1 60 79 96 00  
Fax: [+33] 1 60 77 69 22

**HONG KONG**

Tel: [+852] 2832 7988  
Fax: [+852] 2834 5364

**SCANDINAVIA**

Tel: [+45] 9614 0045  
Fax: [+45] 9614 0047

**SPAIN**

Tel: [+34] (91) 640 11 34  
Fax: [+34] (91) 640 06 40

**UNITED KINGDOM**

Tel: [+44] (0) 1438 742200  
Toll Free: [+44] (0800) 282 388 (UK only)  
Fax: [+44] (0) 1438 727601

**USA**

Tel: [+1] (316) 522 4981  
Toll Free: [+1] (800) 835 2352 (US only)  
Fax: [+1] (316) 522 1360



As we are always seeking to improve our products, the information in this document gives only a general indication of the product capacity, performance and suitability, none of which shall form part of any contract. We reserve the right to make design changes without notice. All trademarks are acknowledged. Parent company Aeroflex, Inc. ©Aeroflex 2004.

[www.aeroflex.com](http://www.aeroflex.com)  
[info-test@aeroflex.com](mailto:info-test@aeroflex.com)



Our passion for performance is defined by three attributes represented by these three icons: solution-minded, performance-driven and customer-focused.

Part No. 46891/909, Issue 2, 04/04