

CT2578/CT2581 Simple Remote Terminal for MIL-STD-1553/1760 & McAir

FEATURES

- ❑ Complete RT Protocol
- ❑ Meets MIL-STD-1553A/B & MIL-STD-1760
- ❑ Simple interface
- ❑ Dual Transceivers (1553 / 1760 or McAir)
- ❑ +5V - Only Power Supply
- ❑ Low Power (0.15 Watts per Channel)
- ❑ Only validated messages transferred
- ❑ Optional Data Wrap Around
- ❑ Packaging – Hermetic Ceramic
 - 119 Lead, 1.335" SQ. x .15" PGA
 - 84 Lead, 1.165" SQ. x .14" CQFP
- ❑ Store Released Signal
- ❑ Any Message may be Illegalized
- ❑ McAir Reduced Response Time Option (inh MC1F)
- ❑ Optional 1760 checksum
- ❑ 1760 Header word identification
- ❑ Latched RT Address
- ❑ MIL-PRF-38534 Compliant Circuits Available
- ❑ Designed for Commercial, Industrial and Aerospace Applications
- ❑ Aeroflex is a Class H & K MIL-PRF-38534 Manufacturer

FUNCTIONAL BLOCK DIAGRAM

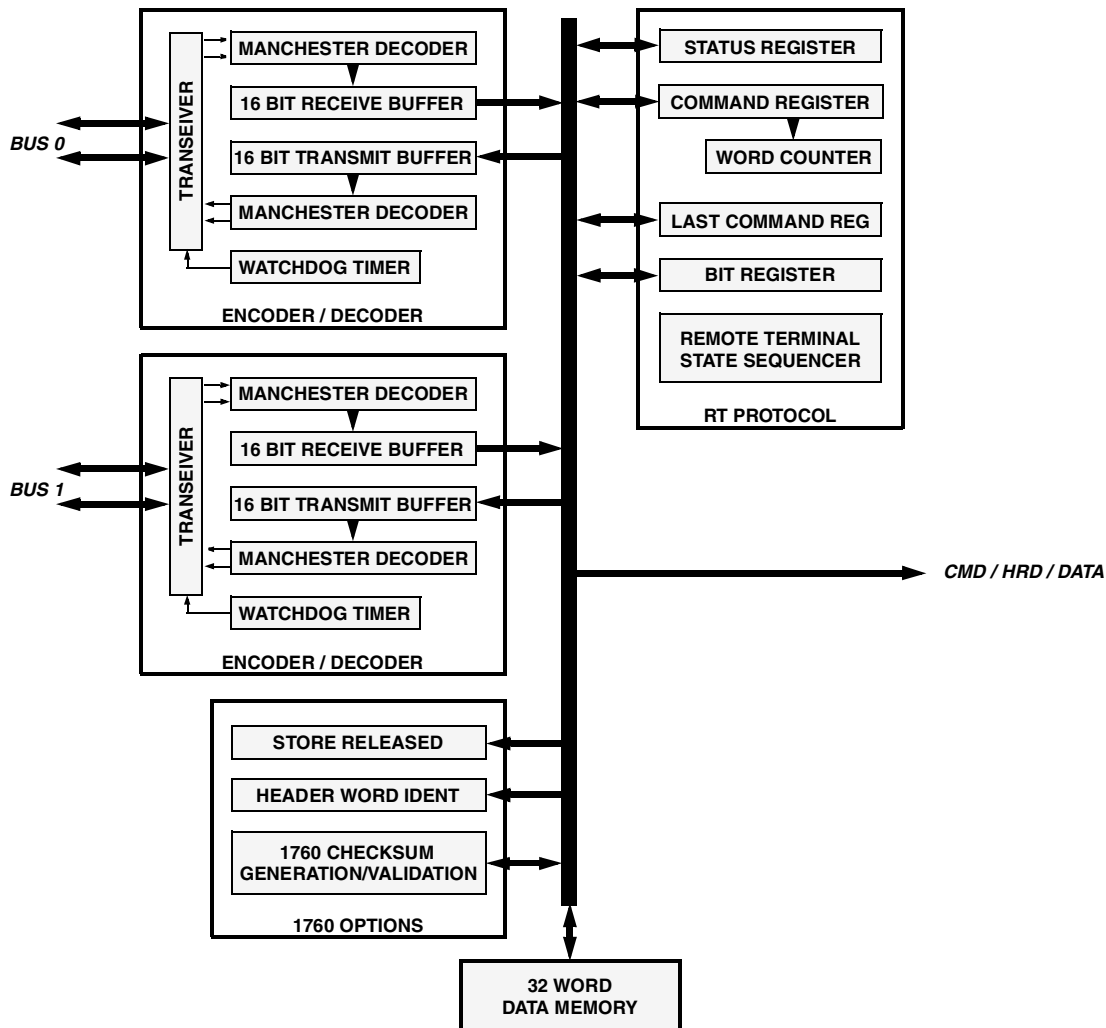

GENERAL DESCRIPTION

CT2578 is for use in simple Remote Terminal applications without the need for a processor or software development.

It provides the complete protocol for a Remote Terminal, supporting all types of message transfers including all 15 mode codes, with comprehensive error checking. Error handling of data is not required by the subsystem. The user interface is a 16 bit bidirectional highway with a few control lines.

The low power transceivers are capable of providing the output voltage required by MIL-STD-1760 and are powered by a +5V supply.

If sinusoidal (McAir) transceivers are required then the part number becomes CT2581. This is the only difference between CT2578 and CT2581.

A 32 word data buffer memory is used to store messages until validation is complete. Only validated messages are transferred to the subsystem at a rate of 500nS per word. Data to be transmitted is transferred from the subsystem to this buffer memory at a maximum rate of 1µS per word. This data memory may be bypassed in the receive mode and data transferred to the subsystem on a word by word basis as it is being received.

The device has an optional RT wrap around capability. When WRAPEN is active, data received at subaddress 1E (30) remains stored in the data buffer memory (i.e. not transferred to the subsystem). If followed by a transmit from subaddress 1E the same data will be transmitted.

There is an option within the device to reduce the response time in order to conform to other standards such as 1553A and McAir. In this mode subaddress 1F is allocated a normal subaddress with subaddress 00 reserved for mode commands.

Any message may be illegalized by applying an active low on the NME discrete status input. The Remote Terminal will respond with the Message Error bit set in the status and not use the information received.

A hardware implementation of the 1760 checksum algorithm within the device may be enabled via signal NENCHK. When transmitting, the checksum word is inserted in the last word position, and when receiving, a valid checksum word will generate the open drain output (STATUS). The STATUS output may be hard wired to any of the discrete status inputs (e.g. Service Request), if it is also hard wired to the input NILLCMD the device will respond to a failed checksum with the selected status bit set and not use the data (i.e. not transfer the data to the subsystem).

In addition to the signal NVCR (valid command word received) which may be used to illegalize commands, a signal NHDR (header word received) is available to the subsystem for verification of the 1760 message header.

The RT address lines are latched on RESET as required by 1760. If all six RT address lines go open circuit the store released signal (STREL) will go high.

The device is packaged in a 119 pin grid array or 84 lead CQFP package.

SIGNAL DESCRIPTIONS

1553 / 1760 DATA BUS

DATABUS 0 Signal is connected to the positive side of the external data bus transformers for bus 0.

NDATABUS 0 Signal is connected to the negative side of the external data bus transformers for bus 0.

DATABUS 1 Signal is connected to the positive side of the external data bus transformers for bus 1.

NDATABUS 1 Signal is connected to the negative side of the external data bus transformers for bus 1.

HARD WIRED

ADDR A-E (Inputs with pull up resistor)

Remote Terminal address inputs for the unit. ADDR A is the least significant bit and ADDR E is the most significant bit. These inputs are internally latched every time the unit is reset. The latched address information is then compared to the incoming command word.

ADDR P (Input with pull up resistor)

Parity bit for the Remote Terminal address inputs. ADDR P must be set to ODD parity. This input is latched as above.

WRAPEN (Input with pull down resistor)

Select Remote Terminal wrap around to subaddress 1E. The Bus Controller sends data to subaddress 1E which remains in the data buffer memory and is available to be sent back on the very next command by the Bus Controller. The data in the data buffer memory in this mode does not get transferred to the subsystem. If the very next command is not a transmit command to subaddress 1E, the data buffer memory is flushed and will respond normally to the next set of commands. If the wrap around test is enabled, data to subaddress 1E must be transferred in the correct sequence.

"0" = Normal mode

"1" = Wrap Around mode

MCAIR (Input with pull down resistor)

This signal sets the unit to respond with a status word within 4µS (dead bus time). Subaddress 1F is also enabled to be a valid subaddress for data. Normally subaddress 00 and 1F are reserved for mode codes.

"1" = 4µS dead bus response time, subaddress 1F used for data.

"0" = 12µS response time, subaddress 1F used for mode codes.

C16MHZ (Input with pull up resistor)

Free running 16 MHz clock input.

SUBSYSTEM INTERFACE

T0-T15 (Bidirectional IO)

16 bit bidirectional highway to transfer all information to / from subsystem. The user can also utilize this bus to monitor Command word and Header word (1760 requirement) for message illegalization.

NRES (Bidirectional IO with pull up resistor)

Bidirectional reset pin. Interface to this pin should be in the form of an open collector pull down driver. The unit will be reset when a low level input is asserted on power up. The pin is bidirectional in that the unit will drive the signal out low after the status response of the mode code Reset Remote Terminal. Upon reset the unit will be able to respond immediately after the rising edge of NRES.

NILLCMD (Input with pull up resistor)

Input to illegalize a command to the Remote Terminal with a clear status response. The signal is sampled after NVCR except non mode code receive commands in which case it is sampled after the last data word has been received. A low on this input will illegalize the message, no transfers to / from the subsystem will take place. The device will respond with a clear status unless a bit has been specifically set. No data will be transmitted following status.

NVCR (Output)

Early indication that the Remote Terminal has received a command and the command word is available on T0-T15. This can be used for message illegalization.

NDATA (Output)

Access to valid data word in real time. Data word available on T0-T15 during active low signal.

NCMDSTRB (Output)

This signal indicates that a completely validated message has been received for standard subaddress data activity. Mode commands with or without data will not generate this signal. The NCMDSTRB signal is 8.5 μ S long and is an indication that a DMA burst will initiate at the end of NCMDSTRB to transfer words between the 32 word data memory and the subsystem. The Command word is available on T0-T15 during this period.

NDATAST (Output)

Signal to transfer normal validated received data from the data buffer memory to the subsystem at a rate of 500nS per word via the T0-T15 highway.

NSSTRB (Input with pull up resistor)

Signal to transfer normal data for transmission from the subsystem to the data buffer memory at a maximum rate of 1 μ S per word via the T0-T15 highway.

C1MHZ (Output)

Free running 1 MHZ clock to subsystem. NSSTRB must be synchronized to this clock.

NENVW (Output)

Signal to transfer Vector word from subsystem to unit in response to 'Transmit Vector Word' mode command via the T0-T15 highway.

NSYNC (Output)

Signal to subsystem indicating receipt of a synchronize mode commands. If the mode code has an associated data word, it will be available on T0-T15 at this time. If there is no associated data word, T0-T15 will be zero.

DISCRETE RT STATUS INPUTS

The following signals are inputs to set the appropriate bits in the Remote Terminals status word. All inputs are sampled after NVCR except non mode code receive commands in which case they are sampled after the last data word has been received. All status inputs are active low.

NME (Input with pull up resistor)

Message Error, illegalizes message. No transfers to / from the subsystem will take place. No data will be transmitted following the status.

NBUSY (Input with pull up resistor)

Subsystem Busy. No data will be transferred to / from the subsystem and no data will be transmitted following status for non mode code transfers.

NTF (Input with pull up resistor)

Terminal Flag.

NSR (Input with pull up resistor)

Service Request.

NSSFLAG (Input with pull up resistor)

Subsystem Flag.

1760 SIGNALS**NENCHK** (Input with pull up resistor)

Enables / disables the internal hardware checksum generation and validation. When enabled, the circuitry will check all incoming data for correct checksum and generate the correct checksum word for an outgoing data transfer.

"0" = Enable checksum circuitry.

"1" = Disable checksum circuitry.

STATUS (Open drain output)

Open drain output will toggle high or low on each incoming data word from the 1553 data bus provided NENCHK is enabled. When the last data word is received the STATUS line is sampled by the protocol circuitry to determine if the checksum for the message is valid. At the end of the message, if STATUS is low then the checksum is not valid. This STATUS signal can be wired to several different pins to customize the units response to a checksum failure. STATUS can be wired to signals such as NILLCMD and NSR which would cause the message to be illegalized and set Service Request bit in the Status.

NHDR (Output)

In MIL-STD-1760, the first data word of a message is defined as a Header word. The NHDR signal indicates the presence of the Header word on the T0-T15 highway as it is received. The Header is also stored in the data buffer memory along with the complete message.

STREL (Output)

When the store is released from the aircraft all the Remote Terminal address inputs go high causing signal STREL to go high.

MESSAGE FORMATS (RT)

BC TO RT TRANSFER

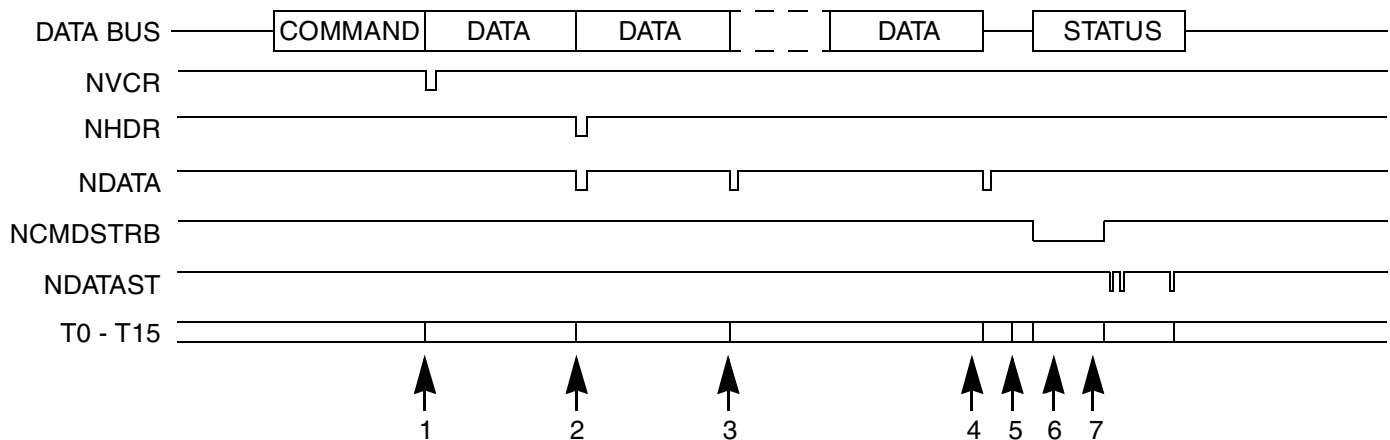

1. Valid command word received, contents available on T0-T15 for illegalization purposes.
2. First valid data word (1760 header word) received, contents available on T0-T15 and stored in 32 word data memory.
3. Second valid data word received, contents available on T0-T15 and stored in 32 word data memory.
4. Last valid data word received, contents available on T0-T15 and stored in 32 word data memory. Status bits must be valid within 250nS.
5. Status register contents transferred to transmit buffer.
6. NCMDSTRB indicates valid message received, command word available on T0-T15 and stored in the 32 word command memory.
7. Data words transferred from 32 word data memory to main memory at 500 nS per word.

RT TO BC TRANSFER

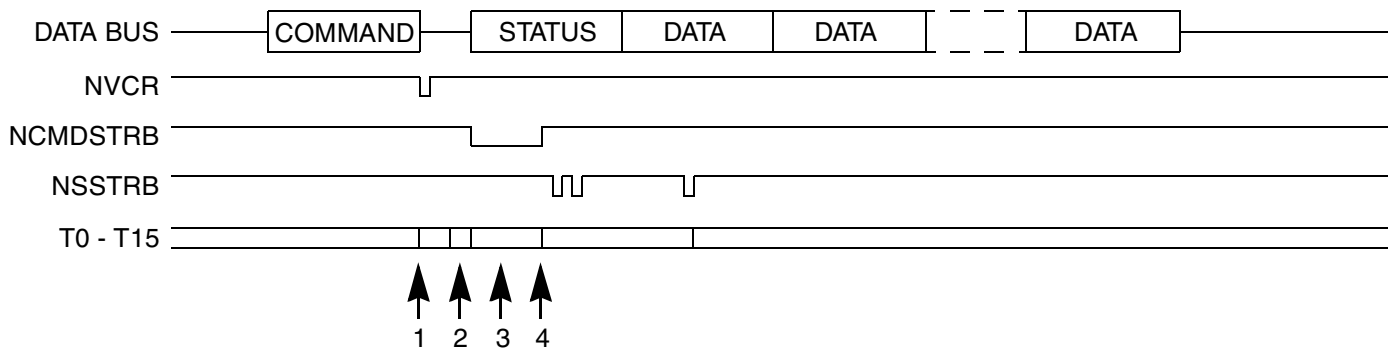

1. Valid command word received, contents available on T0-T15 for illegalization purposes. Status must be valid within 600 nS.
2. Status register contents transferred to transmit buffer.
3. NCMDSTRB indicates valid message received, command word available on T0-T15 and stored in the 32 word command memory.
4. Data words transferred from main memory to 32 word data memory at 1 μ S per word.

RT TO RT TRANSFER (RECEIVING TERMINAL)

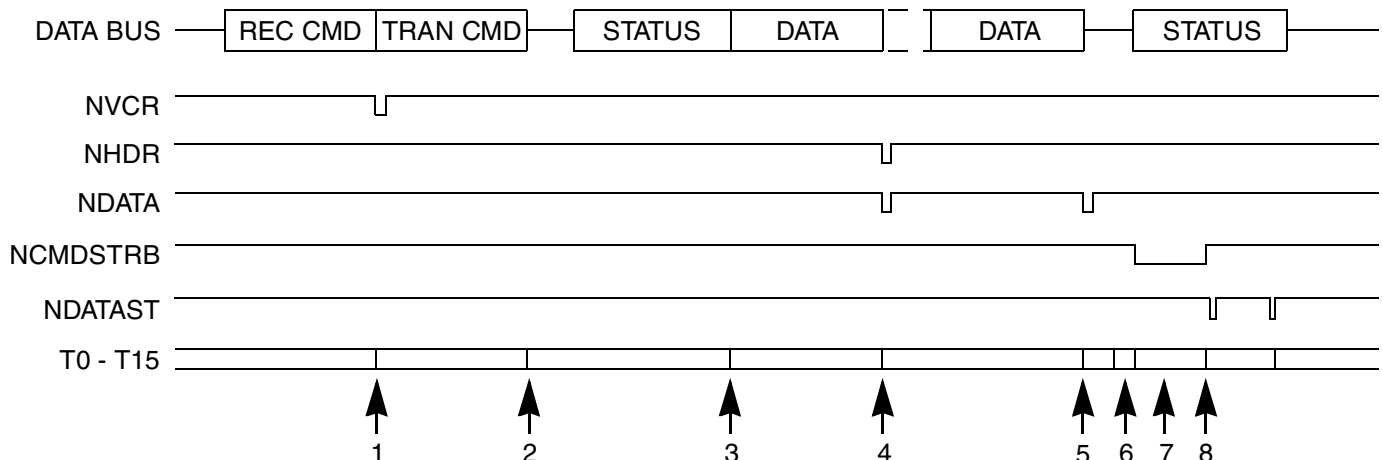

1. Valid receive command word received, contents available on T0-T15 for illegalization purposes.
2. Valid transmit command word received, contents available on T0-T15.
3. Status response of transmitting terminal received.
4. First valid data word (1760 header word) received, contents available on T0-T15 and stored in 32 word data memory.
5. Last valid data word received, contents available on T0-T15 and stored in 32 word data memory. Status bits must be valid within 250nS.
6. Status register contents transferred to transmit buffer.
7. NCMDSTRB indicates valid message received, command word available on T0-T15 and stored in the 32 word command memory.
8. Data words transferred from 32 word data memory to main memory at 500 nS per word.

MODE CODES WITHOUT DATA

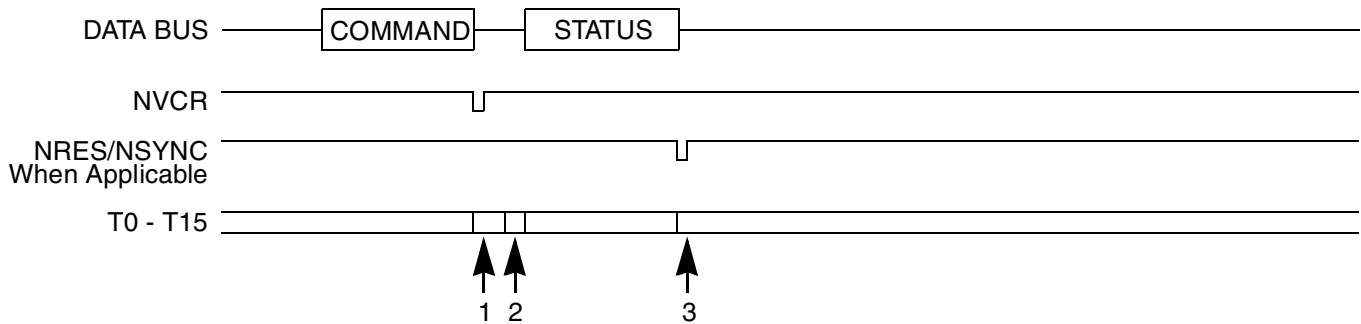

1. Valid command word received, contents available on T0-T15 for illegalization purposes. Status must be valid within 600 nS.
2. Status register contents transferred to transmit buffer.
3. Synchronize mode command, T0-T15 = 0.

MODE CODES WITH DATA RECEIVE

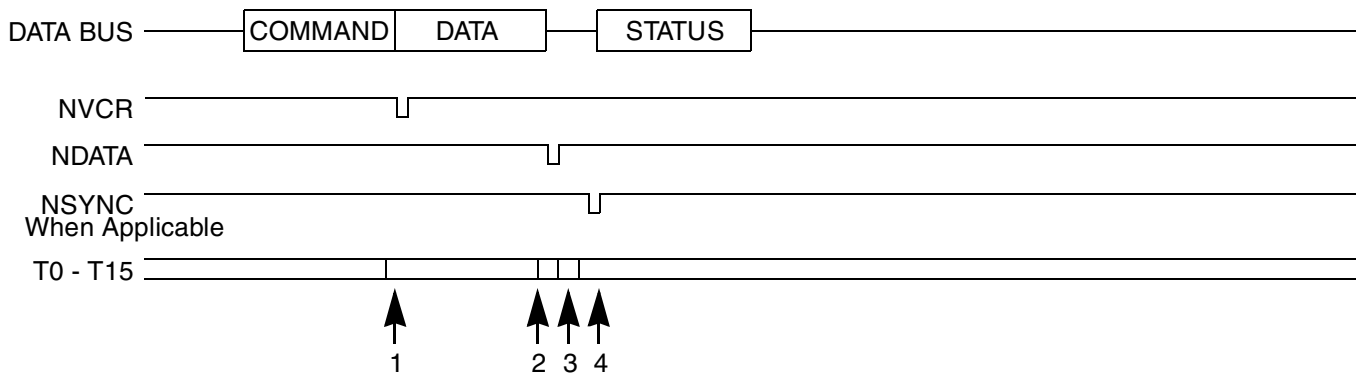

1. Valid command word received, contents available on T0-T15 for illegalization purposes. Status must be valid within 600 nS.
2. Valid data word received, contents available on T0-T15. Synchronize data word stored in 32 word data memory.
3. Status register contents transferred to transmit buffer after message validation.
4. Synchronize data word (when applicable) transferred from 32 word data memory to main memory and available on T0-T15.

MODE CODES WITH DATA TRANSMIT

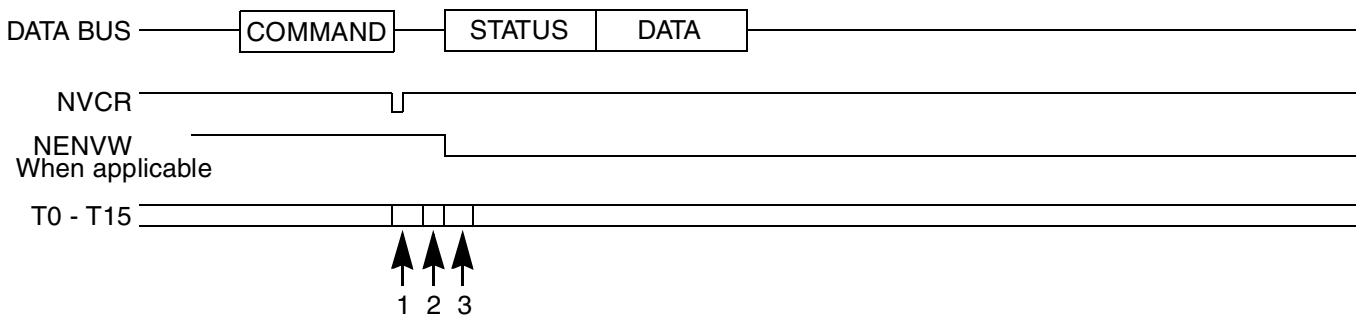

1. Valid command word received, contents available on T0-T15 for illegalization purposes. Status must be valid within 600 nS.
2. Status register contents transferred to transmit buffer after message validation.
3. Vector word or BIT word (when applicable) transferred from main memory to transmit buffer.

BC TO RT TRANSFER BROADCAST

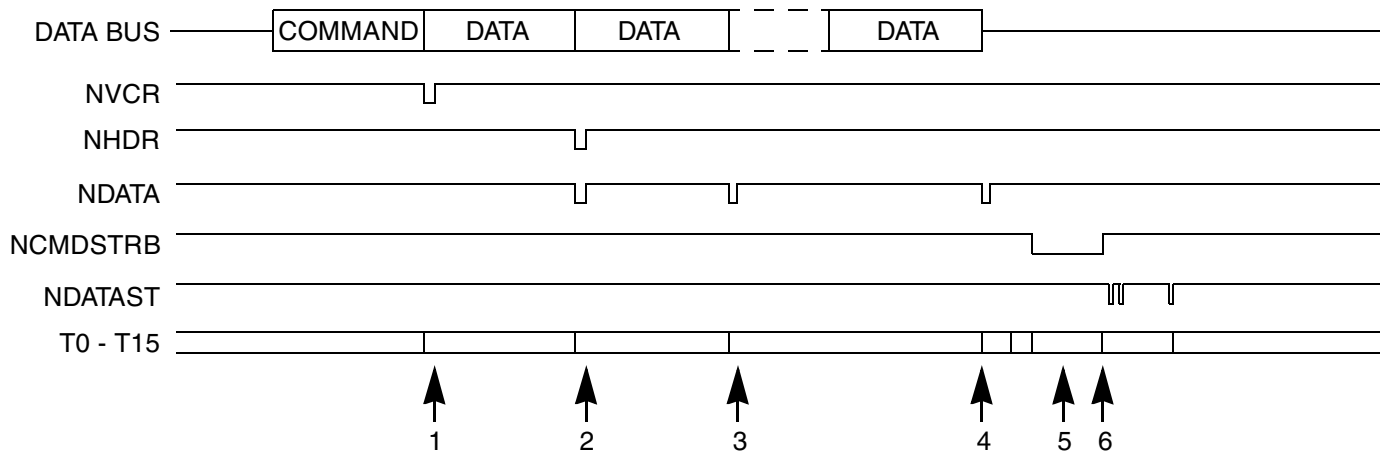

1. Valid command word received, contents available on T0-T15 for illegalization purposes.
2. First valid data word (1760 header word) received, contents available on T0-T15 and stored in 32 word data memory.
3. Second valid data word received, contents available on T0-T15 and stored in 32 word data memory.
4. Last valid data word received, contents available on T0-T15 and stored in 32 word data memory. Status bits must be valid within 250nS.
5. NCMDSTRB indicates valid message received, command word available on T0-T15 and stored in the 32 word command memory.
6. Data words transferred from 32 word data memory to main memory at 500 nS per word.

RT TO RT TRANSFER BROADCAST (RECEIVING TERMINAL)

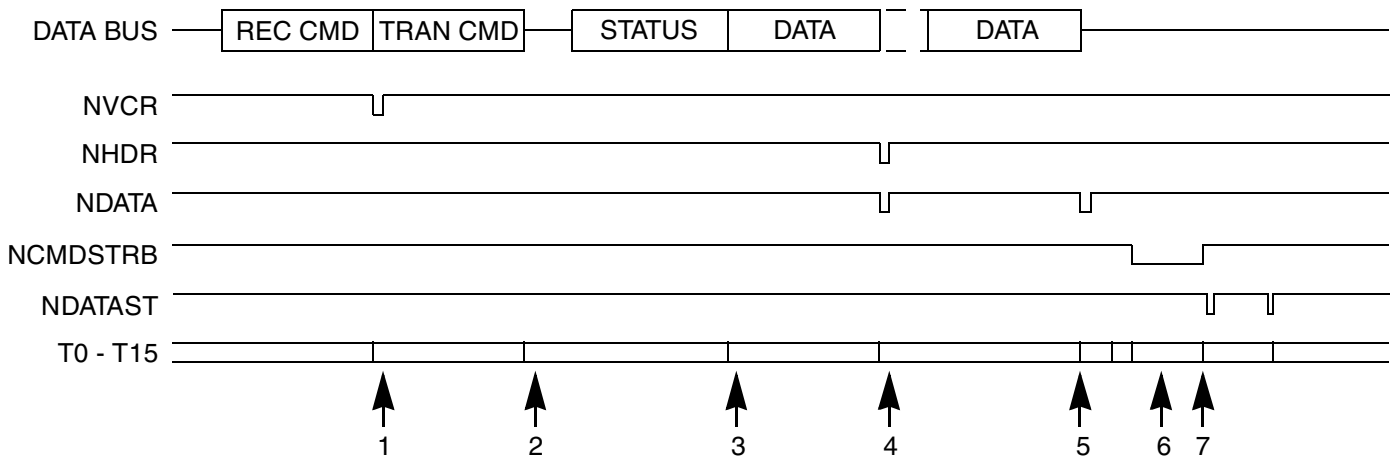

1. Valid receive command word received, contents available on T0-T15 for illegalization purposes.
2. Valid transmit command word received, contents available on T0-T15.
3. Status response of transmitting terminal received.
4. First valid data word (1760 header word) received, contents available on T0-T15 and stored in 32 word data memory.
5. Last valid data word received, contents available on T0-T15 and stored in 32 word data memory. Status bits must be valid within 250nS.
6. NCMDSTRB indicates valid message received, command word available on T0-T15 and stored in the 32 word command memory.
7. Data words transferred from 32 word data memory to main memory at 500 nS per word.

MODE CODES WITHOUT DATA BROADCAST

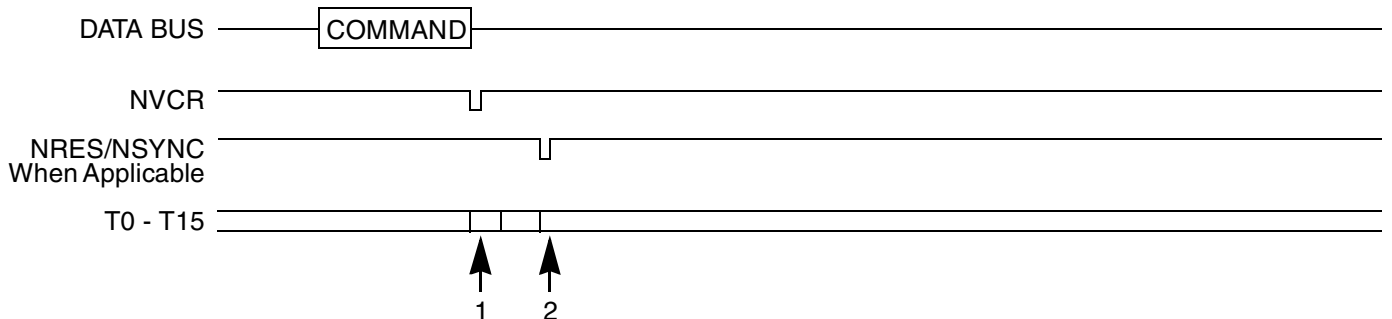

1. Valid command word received, contents available on T0-T15 for illegalization purposes. Status must be valid within 600 nS.
2. Synchronize mode command, T0-T15 = 0.

MODE CODES WITH DATA RECEIVE BROADCAST

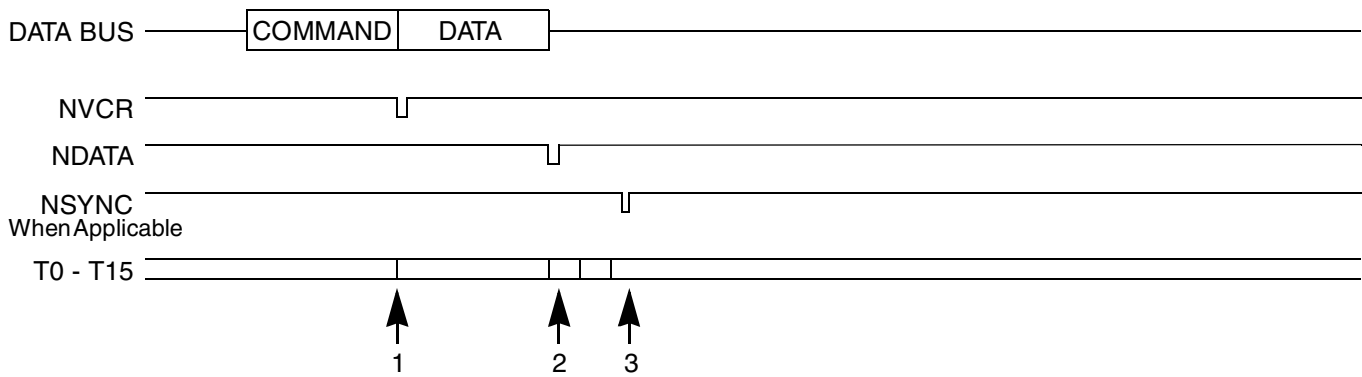

1. Valid command word received, contents available on T0-T15 for illegalization purposes. Status must be valid within 600 nS.
2. Valid data word received, contents available on T0-T15. Synchronize data word stored in 32 word data memory.
3. Synchronize data word (when applicable) transferred from 32 word data memory to main memory and available on T0-T15.

REMOTE TERMINAL DETAIL

COMMAND REGISTER

15	14	13	12	11	10	9	8	7	6	5	4	3	2	1	0
RT ADDRESS					T R	SUBSYSTEM ADDR / MODE					WORD COUNT / MODECODE				

The five most significant bits of the command register contain the Remote Terminal Address.

Bit 10 of the register is the Transmit / Receive bit. If it is set to '1' the device will perform the transmit sequence and it is set to '0' it will perform the receive sequence.

Bits 5 to 9 contain the Subsystem Address but two of these addresses are reserved and one programmable. 11111 (1F) or 00000 (00) indicate that the command is a mode code. The least significant five bits of the command register are used to decode the mode code and are not used as the word counter as a mode code may only have a maximum of one associated word.

111110 (1E) and WRAPEN sets the sequencer up to perform the wrap around function.

The least significant five bits of the command register contain the number of data words to be transmitted or received. 11111 is 31 words and 00000 is 32 words.

STATUS REGISTER

15	14	13	12	11	10	9	8	7	6	5	4	3	2	1	0
RT ADDRESS					M E	I N S T	S R	RESVD		B C S T	B U S Y	S S F L	D B C A	T F	

ME

Message Error: Set internally as a result of an error in the received message or set externally with a discrete pin to illegalise a message.

INST

Instrumentation: Set to zero.

SR

Service Request: Set with a discrete pin or by writing to address 0 00 08.

RESVD

Reserved: Set to zero

BCST

Broadcast Command Received: Set internally.

BUSY

Subsystem Busy: Set with a discrete pin or by writing to address 0 00 04.

SSFL

Subsystem Flag: Set with a discrete pin or by writing to address 0 00 02.

DBCA

Dynamic Bus Control Acceptance: Set with a discrete pin or by writing to address 0 00 01.

TF

Terminal Flag: Set with a discrete pin.

The status register is cleared and the external bits loaded on all commands except 'Transmit Status' and 'Transmit Last Command'. The external status bits (both discrete and programmable) must be valid 600 nS from the rising edge of NVCR for transmit commands and mode codes, and 250 nS from the rising edge of NDATA for the last data word in a receive message.

If discrete status inputs are not used they may be left open circuit.

STATUS RESPONSE TIME

The response time (all commands) measured from the mid bit zero crossing of the last bit of the last word to the mid bit zero crossing of the status word sync is nominally 11.0 μ S.

This time period is used to monitor for more data words on the bus. If a valid sync field followed by four valid Manchester bi-phase bits are detected then this is considered to be another word on the bus.

The response time may be reduced to 6.0 μ S (4.0 μ S dead bus time) by setting the MCAIR input active high.

MESSAGE ILLEGALIZATION

Any command or mode command may be illegalised by setting the NME input active low. The remote terminal will respond with status with the Message Error bit set, provided the message was valid, and not use the information received. There will be no transfers to or from the subsystem.

One way to implement this function is to place a latching PROM to the T0-T10 data bus. The PROM would only have to decode 11 bits (5 bits subaddress, 5 bit word count and 1 bit T/R) and have a one bit output to place a high/low level on the NME input pin. The upper five bits (T11-T15) are just the Remote Terminal address for the unit which is constant so no decode of these bits is necessary. The latching signal for the PROM would be the NVCR line. The NME signal will remain latched and stable until the next rising edge of NVCR.

Reserved mode commands are automatically declared illegal by the device and need not be included in the PROM decode.

All other conditions which require the message error bit to be set are automatic.

1760 CHECKSUM

The 1760 checksum logic is enabled by setting the input NENCHK active low.

For transmit messages the checksum word is generated and inserted in the last word position of the transmitted message.

For received messages the last data word receive (the checksum word) is validated. If this word meets the required criteria the output STATUS remains low. This signal will toggle up and down for each data word received as it is calculating the checksum.

The open drain output (STATUS) signal may be hard wired to any of the discrete status inputs to set the required bit of the status response in the current message. In addition it may be hard wired to the input NILLCMD which will prevent the message being written to memory (e.g. if it is required to set the Service Request bit and not use the data for a failed checksum - hard wire STATUS to NSR and NILLCMD).

1760 HEADER WORD

In 1760 applications the first data word received is designated the header word. An output NHDR is provided to indicate the presence of this word on the highway T0-T15 for verification purposes. A failed header word may be treated in the same way as a failed checksum.

STORE RELEASED

The signal STREL is provided in 1760 applications to indicate to the subsystem that the store is no longer connected to the aircraft.

INITIALIZATION OF THE DEVICE

The device must be reset to a known state on power up. (The RT address will be latched on power up). It will remain inactive until a valid command word is received. If the device is in the process of sequencing a command and a new command is received on the alternative bus, the sequence will be terminated and the device will sequence the new command.

The device will only consider a command word valid if the following conditions are met:

- It contains the correct sync field.
- Correct Manchester bi-phase (16 bits plus parity).
- Correct parity (odd).
- Correct terminal address or broadcast address.
- Does not follow contiguously a valid word on the same bus.

The device will only consider a data word valid if the following conditions are met:

- It contains the correct sync field.
- Correct Manchester bi-phase (16 bits plus parity).
- Correct parity (odd).
- Follows contiguously a valid word on the same bus.

Upon receipt of a valid command word the signal NVCR becomes active low for 500 nS. (The command word is available on T0-T15 during this period for message illegalization).

On all commands except 'Wrap Around Transmit' the 32 data word memory is cleared.

RT TO BC TRANSFER



If a valid command is received to transmit up to 32 data words the device will initially respond with Status.

The signal NCMDSTRB goes low for 8.5µS synchronized to the 1 MHz clock indicating that a completely validated message has been received. The transmit Command word appears on T0-T15 at this time.

If the Busy bit of the Status is set the sequence will terminate after NCMDSTRB.

The end of the NCMDSTRB will initiate the DMA cycle to transfer the data words from the subsystem to the data buffer memory in a single burst.

The subsystem enables the first data word onto T0-T15 and applies a NSSTRB to the device synchronized to the 1 MHz clock, this data is stored in the data buffer memory. The subsystem must continue transferring the correct amount of words to the device in this manner at a rate of between 62.5 kHz and 1 MHz.

Data is transferred from the data buffer memory to the output buffer for transmission as required by the 1553 data bus.

If the 1760 checksum is enabled, the checksum word will be automatically generated and transmitted as the last data word. For example, if a Command is received to transmit five data words the subsystem can load four or five data words. If the subsystem loads four data words the device will generate the last data word for transmission. If the subsystem loads five data words the device will ignore the last data word and transmit the internally generated checksum word instead.

Error Conditions	Action taken by device
1. Invalid command.	No response. Command ignored.
2. Command followed by another word.	No status response. Set message error. Sequence terminated.
3. Broadcast address.	No status response. Set message error. Set broadcast. Sequence terminated.
4. Too few NSSTRB from subsystem.	Message truncated.
5. Too many NSSTRB from subsystem.	Bit 1 of BIT register set. Too many data words will not be transmitted.

Error Conditions	Action taken by device
1. Invalid command.	No response. Command ignored.
2. Invalid data word.	No status response. Set message error. Sequence terminated.
3. Non contiguous data.	No status response. Set message error. Sequence terminated.
4. Too few data words.	No status response. Set message error. Sequence terminated.
5. Too many data words.	No status response. Set message error. Set broadcast. Sequence terminated.

BC TO RT TRANSFER

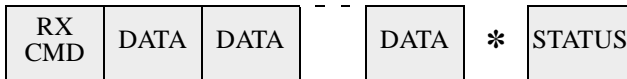

If a valid command is received to receive up to 32 data words and the second word is another command word then an RT to RT transfer has been set up (see RT to RT transfer).

All valid data words received are stored in the data buffer memory until message validation is complete after which the device will respond with Status.

If the command was a broadcast the status transmission will be suppressed and the broadcast bit in the status register set.

Data words are also available on T0-T15 as they are received indicated by signal NDATA.

Only after the message has been completely validated will the data be transferred to the subsystem in a single burst at 500nS per word. This ensures that only complete validated messages are transferred to the subsystem.

When a complete validated message is stored in the data buffer memory the signal NCMDSTRB goes low for 8.5µS synchronized to the 1 MHZ clock indicating that a completely validated message has been received. The receive Command word appears on T0-T15 at this time.

If the Busy bit of the Status is set the sequence will terminate after NCMDSTRB.

The end of the NCMDSTRB will initiate the DMA cycle to transfer the data words from the data buffer memory to the subsystem. The first word received is enabled onto T0-T15 and the signal NDATAST is pulsed low. This sequence is repeated for each data word that was received.

RT TO RT TRANSFER

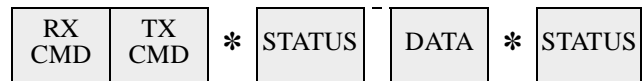

To initiate an RT to RT transfer the Bus Controller will send a receive command to RTA followed contiguously by a transmit command to RTB.

RTB will respond with status and contiguous data (see RT to BC transfer).

RTA (the receiving terminal) will receive the status and data transmitted by RTB and store the received data in the data buffer memory until the entire RT to RT transfer has been validated, after which it will respond with its own status provided it was not a broadcast command, in which case the status transmission will be suppressed and the broadcast bit set. It will then transfer the data to RAM (see BC to RT transfer).

The error detection for the transmitting terminal will be the same as for RT to BC transfer. The error detection for the receiving terminal is as follows:

Error Conditions	Action taken by device
1. Invalid command.	No response. Command ignored.
2. Non contiguous command words.	No status response. Set message error. Sequence terminated.
3. Transmit command followed by another word (excluding command word for RTA, in which case it will respond to the latest command).	No status response. Set message error. Sequence terminated.
4. Transmitting terminal does not respond with status within 16 μ S.	No status response. Set message error. Sequence terminated.
5. Incorrect terminal transmitting.	No status response. Set message error. Sequence terminated.
6. Non contiguous data following status from RTB.	No status response. Set message error. Sequence terminated.
7. Invalid data transmitted from RTB.	No status response. Set message error. Sequence terminated.
8. Too few or too many data words.	No status response. Set message error. Sequence terminated.

Error Conditions	Action taken by device
RECEIVE	
1. Invalid command.	No response. Command ignored.
2. Invalid data word.	No status response. Set message error. Sequence terminated.
3. Non contiguous data.	No status response. Set message error. Sequence terminated.
4. Too few or too many data words.	No status response. Set message error. Sequence terminated.
TRANSMIT	
5. Invalid Transmit command.	No response. Command ignored.
6. Transmit command followed by another word.	No status response. Set message error. Sequence terminated.
7. Transmit Broadcast address.	No status response. Set message error. Set broadcast. Sequence terminated.
8. Transmit word count not equal to receive word count.	No data transmission. Set message error. Sequence terminated.

DYNAMIC BUS CONTROL (00)



The device will respond with status. If the terminal wishes to take over control of the bus, it must set the Dynamic Bus Control Acceptance bit of the status.

WRAP AROUND

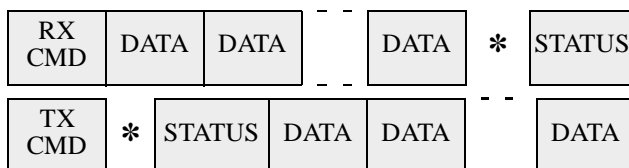

The wrap around capability is for test purposes only. It will test for transfers to and from the Bus Controller without any sub system intervention.

The wrap around sequence will commence on receipt of a valid receive command word containing the wrap around subaddress (1E) providing the WRAPEN input is set high. The data received is stored in the data buffer memory and the device will respond with status. The Bus Controller will then send a transmit command to subaddress 1E and the data contained in the memory will be transmitted following the status.

For the test to operate correctly the number of data words to be transmitted must be the same as the number received.

Error Conditions	Action taken by device
1. Invalid command.	No response. Command ignored.
2. Command followed by another word.	No status response. Set message error. Sequence terminated.
3. T/R bit of command set to zero.	No status response. Set message error. Sequence terminated.
4. Broadcast address.	No status response. Set message error. Set broadcast. Sequence terminated.
5. T/R bit of command set to zero and broadcast address	No status response. Set message error. Set broadcast. Sequence terminated.

SYNCHRONIZE WITHOUT DATA WORD (01)



The device will respond with status. The NSYNC signal will go active low for 500 ns. Throughout this period the highway T0-T15 will be zero and remain at zero until the next command is received.

If the command was a broadcast the status transmission will be suppressed and the broadcast bit in the status register set.

Error Conditions	Action taken by device
1. Invalid command.	No response. Command ignored.
2. Command followed by another word.	No status response. Set message error. Sequence terminated.
3. T/R bit of command set to zero.	No status response. Set message error. Sequence terminated
4. T/R bit of command set to zero and broadcast address	No status response. Set message error. Set broadcast. Sequence terminated.

TRANSMIT STATUS (02)



The status register is not cleared or loaded before it is transmitted, i.e. it contains the resulting status from the previous command.

Error Conditions	Action taken by device
1. Invalid command.	No response. Command ignored.
2. Command followed by another word.	No status response. Set message error. Sequence terminated.
3. T/R bit of command set to zero.	No status response. Set message error. Sequence terminated
4. Broadcast address.	No status response. Set message error. Set broadcast. Sequence terminated.
5. T/R bit of command set to zero and broadcast address	No status response. Set message error. Set broadcast. Sequence terminated.

INITIATE SELF TEST (03)



The device will respond with status. It is at the discretion of the subsystem whether or not to carry out a self test. A subsystem driven self test is contained within the unit.

If the command was a broadcast the status transmission will be suppressed and the broadcast bit in the status register set.

Error Conditions	Action taken by device
1. Invalid command.	No response. Command ignored.
2. Command followed by another word.	No status response. Set message error. Sequence terminated.
3. T/R bit of command set to zero.	No status response. Set message error. Sequence terminated
4. T/R bit of command set to zero and broadcast address	No status response. Set message error. Set broadcast. Sequence terminated.

TRANSMITTER SHUTDOWN (04)



The device will respond with status and shutdown the transmitter on the alternate bus, thus inhibiting any further transmission on that bus.

Once a transmitter has been shutdown it can only be reactivated by the mode commands 'Override Transmitter Shutdown' or 'Reset Remote Terminal'.

If the command was a broadcast the status transmission will be suppressed and the broadcast bit in the status register set.

Error Conditions	Action taken by device
1. Invalid command.	No response. Command ignored.
2. Command followed by another word.	No status response. Set message error. Sequence terminated.
3. T/R bit of command set to zero.	No status response. Set message error. Sequence terminated
4. T/R bit of command set to zero and broadcast address	No status response. Set message error. Set broadcast. Sequence terminated.

VERRIDE TRANSMITTER SHUTDOWN (05)



The device will respond with status and reactivate a shutdown transmitter on the alternate bus.

If the command was a broadcast the status transmission will be suppressed and the broadcast bit in the status register set.

Error Conditions	Action taken by device
1. Invalid command.	No response. Command ignored.
2. Command followed by another word.	No status response. Set message error. Sequence terminated.
3. T/R bit of command set to zero.	No status response. Set message error. Sequence terminated
4. T/R bit of command set to zero and broadcast address	No status response. Set message error. Set broadcast. Sequence terminated.

INHIBIT TERMINAL FLAG (06)



The device will respond with status and then inhibit any further setting of the Terminal Flag bit of the status.

Once the Terminal Flag bit has been inhibited it can only be reactivated by the mode commands 'Override Inhibit Terminal Flag' or 'Reset Remote Terminal'.

If the command was a broadcast the status transmission will be suppressed and the broadcast bit in the status register set.

Error Conditions	Action taken by device
1. Invalid command.	No response. Command ignored.
2. Command followed by another word.	No status response. Set message error. Sequence terminated.
3. T/R bit of command set to zero.	No status response. Set message error. Sequence terminated
4. T/R bit of command set to zero and broadcast address	No status response. Set message error. Set broadcast. Sequence terminated.

VERRIDE INHIBIT TERMINAL FLAG (07)



The device will respond with status and then reactivate the Terminal Flag bit of the status register.

If the command was a broadcast the status transmission will be suppressed and the broadcast bit in the status register set.

Error Conditions	Action taken by device
1. Invalid command.	No response. Command ignored.
2. Command followed by another word.	No status response. Set message error. Sequence terminated.
3. T/R bit of command set to zero.	No status response. Set message error. Sequence terminated
4. T/R bit of command set to zero and broadcast address	No status response. Set message error. Set broadcast. Sequence terminated.

RESET REMOTE TERMINAL (08)



The device will respond with status after which the bidirectional signal NRES to the subsystem will go active low for 500 ns.

Transmitter Shutdown mode commands and Inhibit Terminal Flag mode command will be reactivated.

If the command was a broadcast the status transmission will be suppressed and the broadcast bit in the status register set.

Error Conditions	Action taken by device
1. Invalid command.	No response. Command ignored.
2. Command followed by another word.	No status response. Set message error. Sequence terminated.
3. T/R bit of command set to zero.	No status response. Set message error. Sequence terminated
4. T/R bit of command set to zero and broadcast address	No status response. Set message error. Set broadcast. Sequence terminated.

RESERVED MODE CODES (09-0F)



The status is not cleared or loaded before it is transmitted with the message error bit set.

If the command was a broadcast the status transmission will be suppressed and the broadcast bit in the status register set.

Error Conditions	Action taken by device
1. Invalid command.	No response. Command ignored.
2. Command followed by another word.	No status response. Set message error. Sequence terminated.
3. T/R bit of command set to zero.	No status response. Set message error. Sequence terminated
4. T/R bit of command set to zero and broadcast address	No status response. Set message error. Set broadcast. Sequence terminated.

TRANSMIT VECTOR WORD (10)



On receipt of a valid Command to transmit the Vector Word the device will initially respond with Status.

After the Status response has been initiated the Vector Word will be enabled onto T0-T15 from the subsystem with signal NENVW and transferred to the Output Buffer ready for transmission onto the 1553 data bus following the Status.

Error Conditions	Action taken by device
1. Invalid command.	No response. Command ignored.
2. Command followed by another word.	No status response. Set message error. Sequence terminated.
3. T/R bit of command set to zero.	No status response. Set message error. Sequence terminated
4. Broadcast address.	No status response. Set message error. Set broadcast. Sequence terminated.
5. T/R bit of command set to zero and broadcast address	No status response. Set message error. Set broadcast. Sequence terminated.

SYNCHRONIZE WITH DATA WORD (11)



The Synchronize data word received is stored in the data buffer memory until message validation is complete after which the device will respond with Status.

If the command was a broadcast the status transmission will be suppressed and the broadcast bit in the status register set.

After the Status response has been initiated the Synchronize Word will be transferred to the subsystem. The NSYNC signal will go active low for 500nS during which time T0-T15 will be set to the data word received.

Error Conditions	Action taken by device
1. Invalid command.	No response. Command ignored.
2. Command not followed contiguously by data word	No status response. Set message error. Sequence terminated.
3. Command followed by too many words.	No status response. Set message error. Sequence terminated
4. T/R bit of command set to one.	No status response. Set message error. Sequence terminated.
5. T/R bit of command set to one and broadcast address	No status response. Set message error. Set broadcast. Sequence terminated.

TRANSMIT LAST COMMAND (12)



The status response contains the resulting status from the previous command.

The data word transmitted following the status word contains the previous valid command (provided it was not Transmit Last Command).

Error Conditions	Action taken by device
1. Invalid command.	No response. Command ignored.
2. Command followed by another word.	No status response. Set message error. Sequence terminated.
3. T/R bit of command set to zero.	No status response. Set message error. Sequence terminated
4. Broadcast address.	No status response. Set message error. Set broadcast. Sequence terminated.
5. T/R bit of command set to zero and broadcast address	No status response. Set message error. Set broadcast. Sequence terminated.

TRANSMIT BIT WORD (13)



On receipt of a valid Command to transmit the BIT Word the device will respond with Status followed by the BIT word, after which the BIT register is cleared.

Bits 2 to 15 are always zero. Bit 1 is set if the subsystem sends too many NSSTRB's.

Error Conditions	Action taken by device
1. Invalid command.	No response. Command ignored.
2. Command followed by another word.	No status response. Set message error. Sequence terminated.
3. T/R bit of command set to zero.	No status response. Set message error. Sequence terminated
4. Broadcast address.	No status response. Set message error. Set broadcast. Sequence terminated.
5. T/R bit of command set to zero and broadcast address	No status response. Set message error. Set broadcast. Sequence terminated.

SELECTED TRANSMITTER SHUTDOWN (14)



This mode command is not normally used in dual redundant systems.

The device will respond with status and shut down the transmitter on the bus designated by the two least significant bits of the data word.

The bus addresses of the device are channel 0 - 00, channel 1 - 01. If the command is received on the same bus as the designated shut down bus then the device will respond with status and no shut down will occur.

Once a transmitter has been shut down it can only be reactivated by an 'Override Shutdown Command' or 'Reset Remote Terminal'.

If the command was a broadcast the status transmission will be suppressed and the broadcast bit in the status register set.

Error Conditions	Action taken by device
1. Invalid command.	No response. Command ignored.
2. Command not followed contiguously by data word	No status response. Set message error. Sequence terminated.
3. Command followed by too many words.	No status response. Set message error. Sequence terminated
4. T/R bit of command set to one.	No status response. Set message error. Sequence terminated.
5. T/R bit of command set to one and broadcast address	No status response. Set message error. Set broadcast. Sequence terminated.

OVERRIDE SEL TRANSMITTER SHUTDOWN(15)



This mode command is not normally used in dual redundant systems.

The device will respond with status and reactivate a shutdown transmitter on the bus designated by the two least significant bits of the data word.

The bus addresses of the device are channel 0 - 00, channel 1 - 01. If the command is received on the same bus as the designated override shutdown bus then the device will respond with status and no reactivation will occur.

If the command was a broadcast the status transmission will be

suppressed and the broadcast bit in the status register set.

Error Conditions	Action taken by device
1. Invalid command.	No response. Command ignored.
2. Command not followed contiguously by data word	No status response. Set message error. Sequence terminated.
3. Command followed by too many words.	No status response. Set message error. Sequence terminated.
4. T/R bit of command set to one.	No status response. Set message error. Sequence terminated.
5. T/R bit of command set to one and broadcast address	No status response. Set message error. Set broadcast. Sequence terminated.

RESERVED MODE CODES (16-1F)



The status is not cleared or loaded before it is transmitted with the message error bit set.

If the command was a broadcast the status transmission will be suppressed and the broadcast bit in the status register set.

Error Conditions	Action taken by device
T/R = 1	
1. Invalid command.	No response. Command ignored.
2. Command followed by another word.	No status response. Set message error. Sequence terminated.
T/R = 0	
3. Invalid command.	No response. Command ignored.
4. Command not followed contiguously by data word.	No status response. Set message error. Sequence terminated.
5. Command followed by too many data words.	No status response. Set message error. Sequence terminated.

DETAILED TIMING

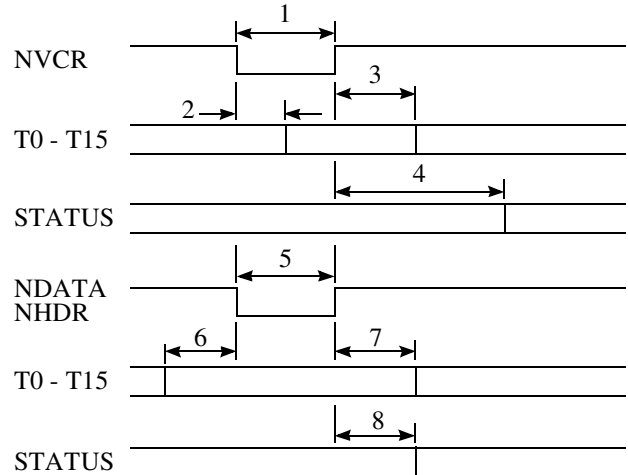

	MIN	MAX	UNIT
1. NVCR pulse duration	500	650	nS
2. NVCR to T0-T15 valid	250		nS
3. NVCR to T0-T15 invalid	250		nS
4. NVCR to discrete status inputs (not rec)		600	nS
5. NDATA & NHDR pulse duration	475	525	nS
6. T0-T15 valid to NDATA & NHDR	250		nS
7. NDATA & NHDR to T0-T15 invalid	250		nS
8. Last NDATA to discrete status inputs (rec)		250	nS

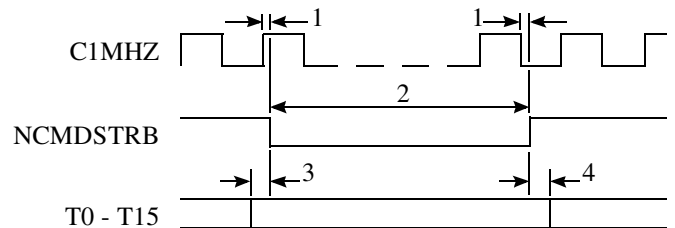

	MIN	MAX	UNIT
1. C1MHZ to NCMDSTRB		75	nS
2. NCMDSTRB duration	8475	8525	nS
3. T0-T15 valid to NCMDSTRB	100		nS
4. NCMDSTRB to T0-T15 invalid	100		nS

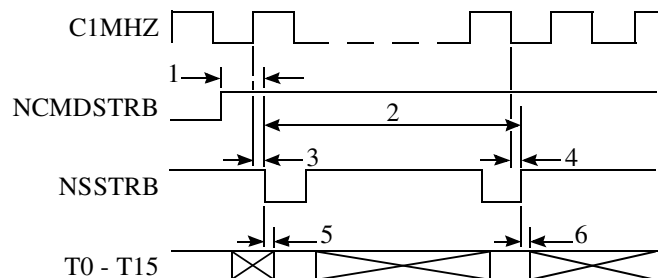

OPERATING CONDITIONS

MIN NOM MAX UNIT

ABSOLUTE MAXIMUM RATINGS

V _{DD} Supply voltage	+7	Volts
V _{SS} Supply voltage	0	Volts
V _{IH} High level input voltage	V _{DD} +0.5	Volts
V _{IL} Low level input voltage	V _{SS} -0.5	Volts
Operating free air temperature range	-55 to +125	°C
Storage temperature range	-65 to +150	°C

RECOMMENDED OPERATING CONDITIONS

	MIN	NOM	MAX	UNIT
V _{DD} Supply voltage	4.75	5.0	5.5	Volts
Free air temperature range	-55		+125	°C

ELECTRICAL CHARACTERISTICS

DIGITAL SIGNALS

MIN NOM MAX UNIT

A1. INPUT WITH PULL UP

V _{IH} High level input voltage	2.4		oc	Volts
V _{IL} Low level input voltage	V _{SS}		0.8	Volts
I _{IH} High level input current	10			µA
I _{IL} Low level input current	35	65	120	µA
C _{IN} Input capacitance			10	pf

A2. INPUT WITH PULL UP

V _{IH} High level input voltage	2.4		oc	Volts
V _{IL} Low level input voltage	V _{SS}		0.8	Volts
I _{IH} High level input current			10	µA
I _{IL} Low level input current	450	800	1500	µA
C _{IN} Input capacitance			10	pf

B. INPUT WITH PULL DOWN

V _{IH} High level input voltage	2.4		V _{DD}	Volts
V _{IL} Low level input voltage	oc		0.8	Volts
I _{IH} High level input current	35	65	120	µA
I _{IL} Low level input current			10	µA
C _{IN} Input capacitance			10	pf

C. OUTPUT

V _{OH} High level output voltage	V _{DD} -0.5		V _{DD}	Volts
V _{OL} Low level output voltage			0.4	Volts
I _{OH} High level output current	2.0	5.5	10.0	mA
I _{OL} Low level output current	2.0	5.5	10.0	mA

D. OPEN DRAIN OUTPUT

V _{OH} High level output voltage			oc	Volts
V _{OL} Low level output voltage			0.4	Volts
I _{OH} High level output current			10	µA
I _{OL} Low level output current	2.0	5.5	10.0	mA

E. Not Used

F. INPUT OUTPUT

V _{IH} High level input voltage	2.4		V _{DD}	Volts
V _{IL} Low level input voltage	V _{SS}		0.8	Volts
I _{IH} High level input current			10	µA
I _{IL} Low level input current			10	µA
C _{IN} Input capacitance			10	pf
V _{OH} High level output voltage	V _{DD} -0.5		V _{DD}	Volts
V _{OL} Low level output voltage			0.4	Volts
I _{OH} High level output current	2.0	5.5	10.0	mA
I _{OL} Low level output current	2.0	5.5	10.0	mA
I _{HZ} High impedance IO current			10	µA

G. INPUT OUTPUT WITH PULL UP

V _{IH} High level input voltage	oc		oc	Volts
V _{IL} Low level input voltage	V _{SS}		0.8	Volts
I _{IH} High level input current			10	µA
I _{IL} Low level input current	450	800	1500	µA
C _{IN} Input capacitance			10	pf
V _{OH} High level output voltage	V _{DD} -0.5		V _{DD}	Volts
V _{OL} Low level output voltage			0.4	Volts
I _{OH} High level output current	0.5	1.0	1.8	mA
I _{OL} Low level output current	1.5	5.0	9.0	mA

DATA BUS SIGNALS

H. TRANSMITTER

I _O Driver peak output current			600	mA
V _O Differential output level point A-A' (R _L =35 ohms) on 1760 BUS	7.0	7.5	9.0	VP-P
T _{RF} Rise and fall times (10%-90% of p-p output)	100	200	300	nS
V _{OE} Output offset 2.5µS after mid bit crossing of parity, point A-A' (R _L =35 ohms)	-90		90	mV
V _O Differential output level point A-A' (R _L =35 ohms) on 1553 BUS	6.0	7.5	9.0	VP-P

H. RECEIVER

V _{IDR} Differential input level point P-P' (TXFMR-2.12:1)		14	20	VP-P
CMRR Common mode rejection ratio	45			dB
V _{TH} Input threshold voltage referred to the bus (100KHz-1MHz)	0.60	0.82	1.20	VP-P

PIN ASSIGNMENTS - PGA PACKAGE

2578/81-02-XX-YY-P119

PIN No	Signal	IO Type	PIN No	Signal	IO Type
G12	STREL (-12 only)	C	N1	ADDR D	A1
F12	NSR	A2	M3	ADDR C	A1
E12	WRAPEN	B	L4	ADDR B	A1
E11	T 0	F	N3	ADDR A	A1
C12	T 1	F	N4	ADDR P	A1
D11	T 2	F	N5	DATABUS 0	H
A13	T 3	F	L6	NDATABUS 0	H
B11	T 4	F	L7	VDD	
C10	T 5	F	M7	VSS	
A11	T 6	F	N9	C16MHZ	A2
A10	T 7	F	N10	NDATA	C
A9	DATABUS 1	H	M11	NRES	G
C8	NDATABUS 1	H	L10	NSSTRB	A1
C7	VDD		M12	C1MHZ	C
B7	VSS		L11	NCMDSTRB	C
C6	NILLCMD	A2	K11	NDATAST	C
A4	T 8	F	K12	NENVW	C
A3	T 9	F	J12	NSSFLAG	A2
C4	T 10	F	H11	NBUSY	A2
A2	T 11	F	G13	NHDR (-12 only)	C
B2	T 12	F	M9	LA (-12 only)	A1
D3	T 13	F	G1	NVALCHK (-12 only)	C
C1	T 14	F	F2	N/C	
E3	T 15	F	M5	N/C	
E1	NSYNC	C	N8	N/C	
F1	MCAIR	B	H12	N/C	
G3	STATUS (-12 only)	D	B9	N/C	
H2	NENCHK (-12 only)	A1	A6	N/C	
J2	NVCR	C	A5	N/C	
J3	NTF	A2	B5	N/C	
L2	NME	A2	B4	N/C	
K3	ADDR E	A1	B3	N/C	

PIN ASSIGNMENTS - FLAT PACKAGE

2578/81-02-XX-YY-F84

#	Signal	IO Type	#	Signal	IO Type
1	T12	F	43	C1MHZ	C
2	T13	F	44	NCMDSTRB	C
3	T14	F	45	NDAATAST	C
4	T15	F	46	NENVW	C
5	NSYNC	C	47	NSSFLAG	A2
6	MCAIR	B	48	NBUSY	A2
7	NVALCHK (-12 only)	C	49	N/C	
8	STATUS (-12 only)	D	50	NHDR (-12 only)	C
9	N/C		51	N/C	
10	N/C		52	STREL (-12 only)	C
11	NENCHK (-12 only)	A1	53	NSR	A2
12	NVCR	C	54	N/C	
13	BCST	C	55	N/C	
14	NTF	A2	56	WRAPEN	B
15	N/C		57	N/C	
16	N/C		58	T0	F
17	NME	A2	59	N/C	
18	ADDRE	A1	60	N/C	
19	N/C		61	T1	F
20	N/C		62	T2	F
21	ADDRD	A1	63	N/C	
22	ADDRC	A1	64	N/C	
23	ADDRB	A1	65	N/C	
24	N/C		66	T3	F
25	ADDRA	A1	67	T4	F
26	N/C		68	T5	F
27	N/C		69	N/C	
28	ADDRP	A1	70	T6	F
29	DATA 0 (BUS)	H	71	N/C	
30	NDAATA 0 (BUS)	H	72	N/C	
31	N/C		73	T7	F
32	N/C		74	DATA 1 (BUS)	H
33	N/C		75	NDAATA 1 (BUS)	H
34	VDD		76	N/C	
35	VSS		77	N/C	
36	C16MHZ	A2	78	VDD	
37	LA (-12 only)	A1	79	VSS	
38	NDAATA	C	80	NILLCMD	A2
39	N/C		81	T8	F
40	N/C		82	T9	F
41	NRES	G	83	T10	F
42	NSSTRB	A1	84	T11	F

PACKAGE OUTLINE

Flat Package – 84 Leads CQFP

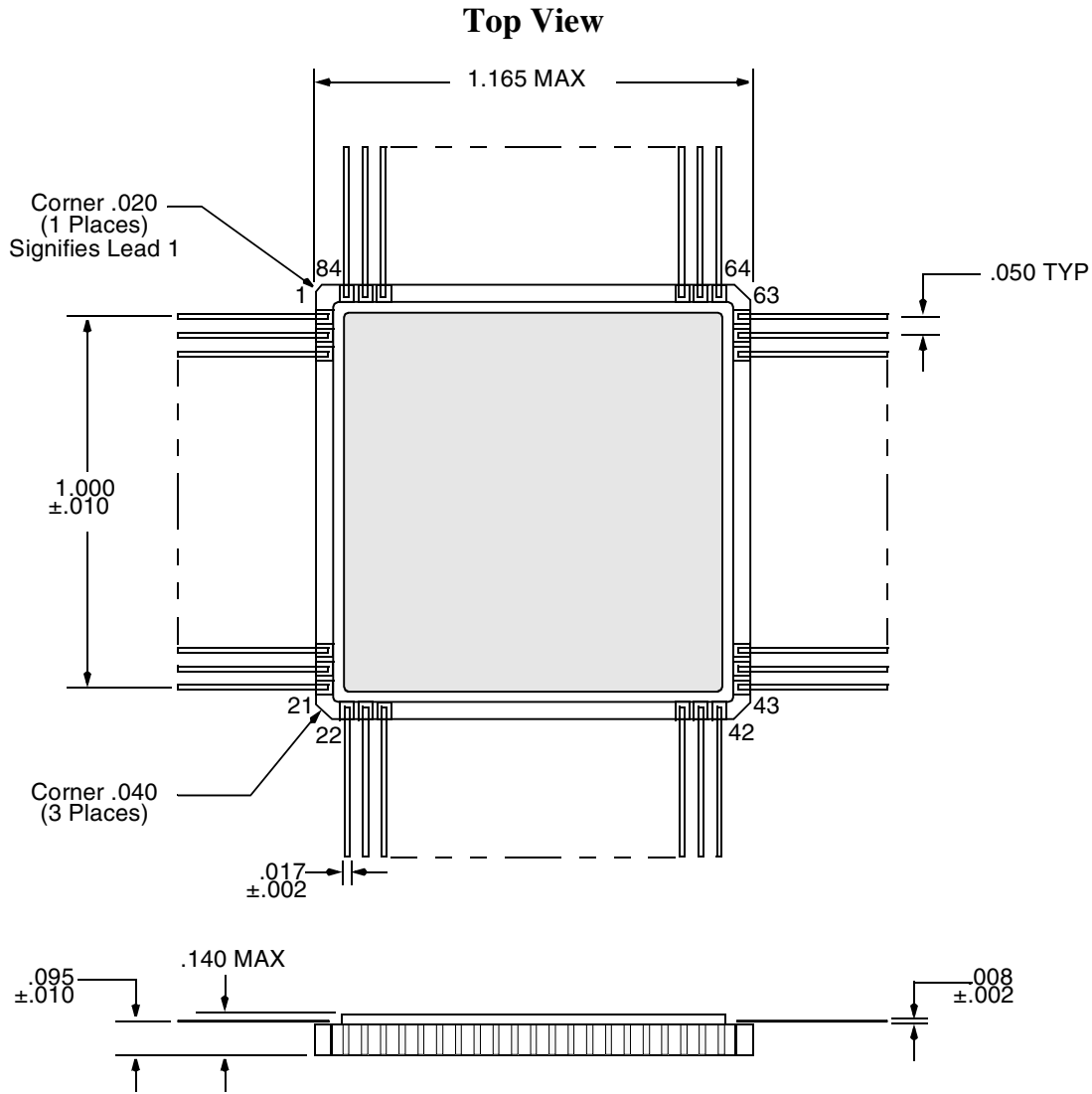

POWER SUPPLY REQUIREMENTS

CURRENT

	MAX	UNIT
Transmitter standby (both channels)	60	mA
25% duty cycle (one channel)	220	mA
50% duty cycle (one channel)	350	mA

POWER DISSIPATION

	MAX	UNIT
Transmitter standby (both channels)	0.3	Watts
50% duty cycle (one channel)	0.6	Watts
100% duty cycle (one channel)	0.9	Watts

POWER SUPPLY DECOUPLING

To maximize stabilization of the devices transceivers, a 4.7µf and a 0.1µf capacitor should be connected in parallel from the +5V supply to ground.

APPLICATION NOTE

CIRCUIT TO TRANSFER DATA FROM SUBSYSTEM

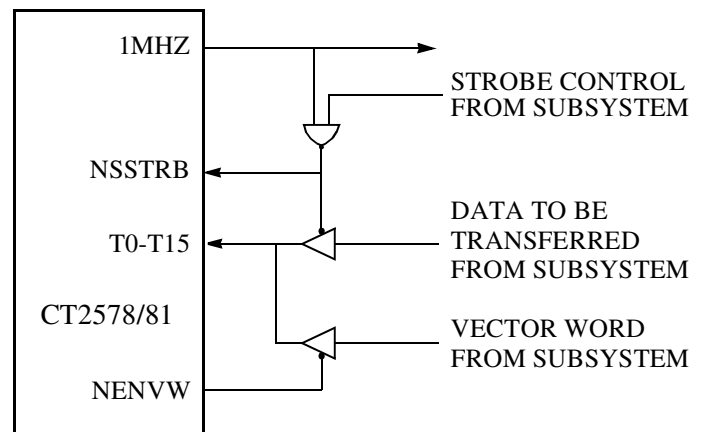

PACKAGE OUTLINE

Plug In Package – 119 Pins PGA

Bottom View

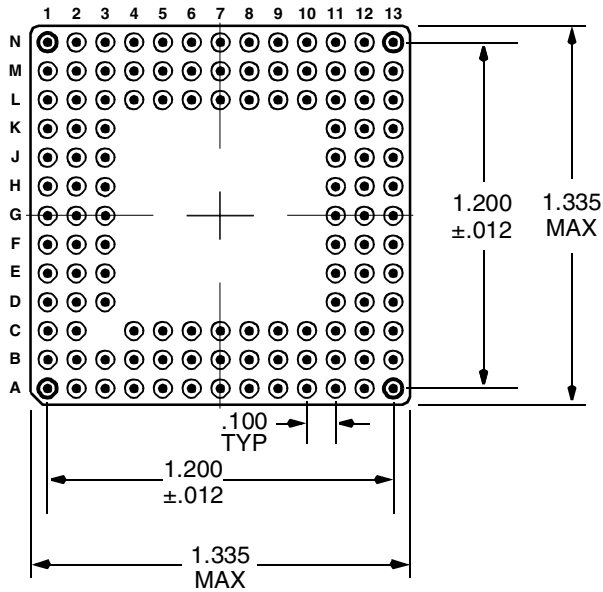

Side View

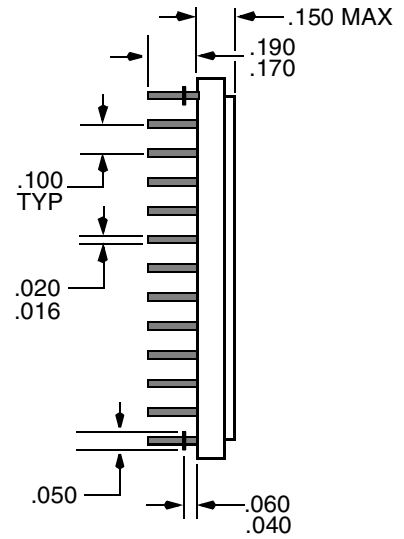

.040 REF 45°
CHAMFER

Top View

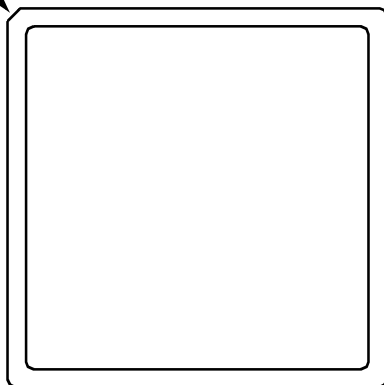

ORDERING INFORMATION

Model Number *	MIL-STD-1760 Pinout	McAir Compliant	DESC Part Number	Package
CT2578-02-QM-P119			TBD	119 Pin PGA
CT2578-02-XT-P119				
CT2578-02-IN-P119				
CT2578-02-CG-P119				
CT2578-12-QM-P119	✓			
CT2578-12-XT-P119	✓			
CT2578-12-IN-P119	✓			
CT2578-12-CG-P119	✓			
CT2578-02-QM-F84				84 Lead CQFP
CT2578-02-XT-F84				
CT2578-02-IN-F84				
CT2578-02-CG-F84				
CT2578-12-QM-F84	✓			
CT2578-12-XT-F84	✓			
CT2578-12-IN-F84	✓			
CT2578-12-CG-F84	✓			
CT2581-02-QM-P119		✓	119 Pin PGA	
CT2581-02-XT-P119		✓		
CT2581-02-IN-P119		✓		
CT2581-02-CG-P119		✓		
CT2581-02-QM-F84		✓	84 Lead CQFP	
CT2581-02-XT-F84		✓		
CT2581-02-IN-F84		✓		
CT2581-02-CG-F84		✓		

*** Screening Code Breakdown**

QM = MIL-STD-883 Compliant
 XT = Extended Temperature Range (-55°C to +125°C)
 IN = Industrial Temperature Range (-40°C to +85°C)
 CG = Commercial Temperature Range (-0°C to +70°C)

PLAINVIEW, NEW YORK
 Toll Free: 800-THE-1553
 Fax: 516-694-6715

INTERNATIONAL
 Tel: 805-778-9229
 Fax: 805-778-1980

NORTHEAST
 Tel: 603-888-3975
 Fax: 603-888-4585

SE AND MID-ATLANTIC
 Tel: 321-951-4164
 Fax: 321-951-4254

WEST COAST
 Tel: 949-362-2260
 Fax: 949-362-2266

CENTRAL
 Tel: 719-594-8017
 Fax: 719-594-8468

www.aeroflex.com info-ams@aeroflex.com



Aeroflex Microelectronic Solutions reserves the right to change at any time without notice the specifications, design, function, or form of its products described herein. All parameters must be validated for each customer's application by engineering. No liability is assumed as a result of use of this product. No patent licenses are implied.



Our passion for performance is defined by three attributes represented by these three icons: solution-minded, performance-driven and customer-focused