

# CA-91X

## Directional Couplers



### Specifications:

Parameter	Specification	Units
Frequency Range (Min)	12.4 – 18.0	GHz
Frequency Flatness	±0.50	dB
Directivity (Min)	15	dB
Input / Output VSWR (Max)	1.4	Ratio
Loss Above Coupling (Max)	0.55	dB
Peak Power (Max)	2	kW
Avg. Power	30	Watts

Outline (inches)	"A"	"B"	"C"	"D"	"E"
8	0.9	0.5	-	-	0.45

### Notes:

1. Rugged 4 hole connector construction insures superiority.
2. For all 30dB couplers "B" dimension is .55 inches.
3. 50 Ohm termination is supplied on each unit delivered. Power rating is 1 Watt at 25°C.
4. Coupling includes frequency flatness & coupling measurement in reference to the input port. Coupling is standard on these units.

### Environmental Specifications:

Designed to meet:

MIL-E-5400, MIL-STD-202, MIL-E-16400

Operating Temp: -55°C to +125°C

Storage Temp: -65°C to +150°C

Humidity: MIL-STD-202F, M103, Cond B

Shock: MIL-STD-202F, M213, Cond B

Altitude: MIL-STD-202F, M105, Cond B

Vibration: MIL-STD-202F, M204, Cond B

Thermal Shock: MIL-STD-202F, M107, Cond A

Temperature Cycle: MIL-STD-202F, M105C, Cond D

### Screening:

Internal Visual per MIL-STD-883, Method 2017

Temperature Cycle: -65 °C to +100 °C, 10 cycles

Hermetically-sealed switches are fine and gross leak checked per MIL-STD-883, Method 1014.

Optional High-Rel screening available upon request. Contact the factory to discuss your screening requirements.

### Mechanical Specifications:

Case Style: CA Outline

Connectors: SMA Female per MIL-C-39012

Connector Control: Micro-D 21 Pin

Bias & Control Pins: ø0.02" x 0.15" long

Weight: 19g max

Mounting: ø0.10" through holes (4) places



40 Industrial Way East, Eatontown, NJ 07724 [USA]  
 Phone: (732) 460-0212, Fax: (732) 460-0214  
[www.aeroflex.com/acc](http://www.aeroflex.com/acc), email: [acc-sales@eroflex.com](mailto:acc-sales@eroflex.com)

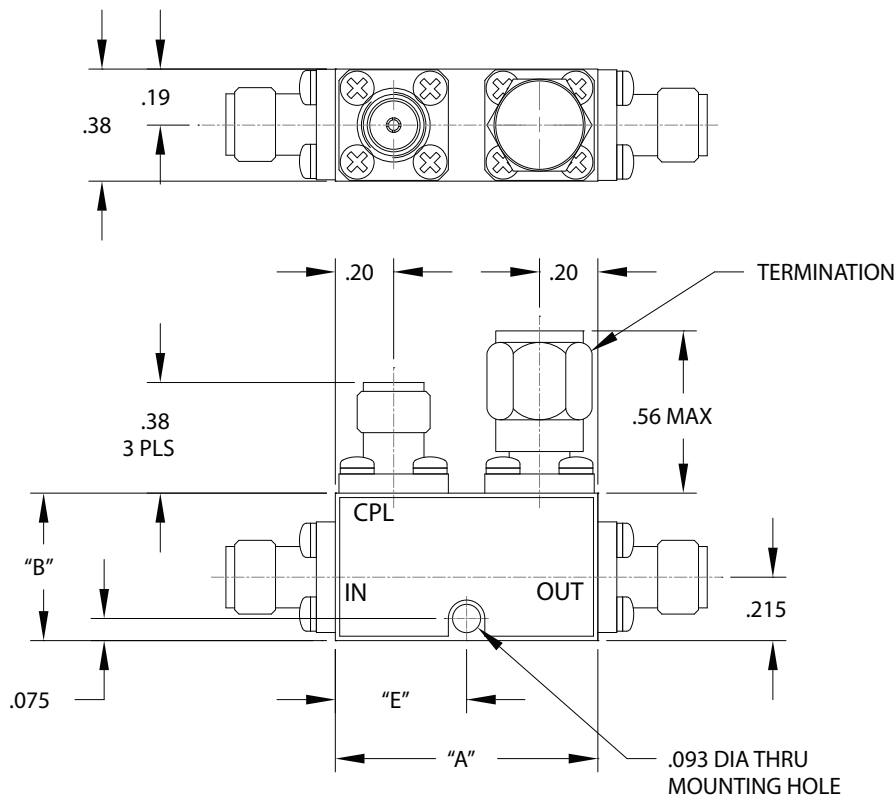

OUTLINE CASE STYLE CA

### Part Number Ordering Information:

Example:	CA-916
CA-91X:	X in the part number represents coupling value
6:	6dB+/-1.0dB
1:	10dB+/-1.2dB
2:	20dB+/-1.2dB
3:	30dB+/-1.2dB

**Aeroflex Control Components**  
Aeroflex Microelectronic Solutions  
40 Industrial Way East  
Eatontown, NJ 07724 [USA]  
Fax: (732) 460-0214

Sales  
Phone: (732) 460-0212  
ACC-sales@aeroflex.com

[www.aeroflex.com/Microwave](http://www.aeroflex.com/Microwave) [www.aeroflex.com/ACC](http://www.aeroflex.com/ACC)

Aeroflex Control Components reserves the right to make changes to any products and services herein at any time without notice. Consult Aeroflex or an authorized sales representative to verify that the information in this data sheet is current before using this product. Aeroflex does not assume any responsibility or liability arising out of the application or use of any product or service described herein, except as expressly agreed to in writing by Aeroflex; nor does the purchase, lease, or use of a product or service from Aeroflex convey a license under any patent rights, copyrights, trademark rights, or any other of the intellectual rights of Aeroflex or of third parties.

Copyright 2011 Aeroflex Control Components. All rights reserved.

ISO 9001:2008 certified



Our passion for performance is defined by three attributes represented by these three icons: solution-minded, performance-driven and customer-focused.